

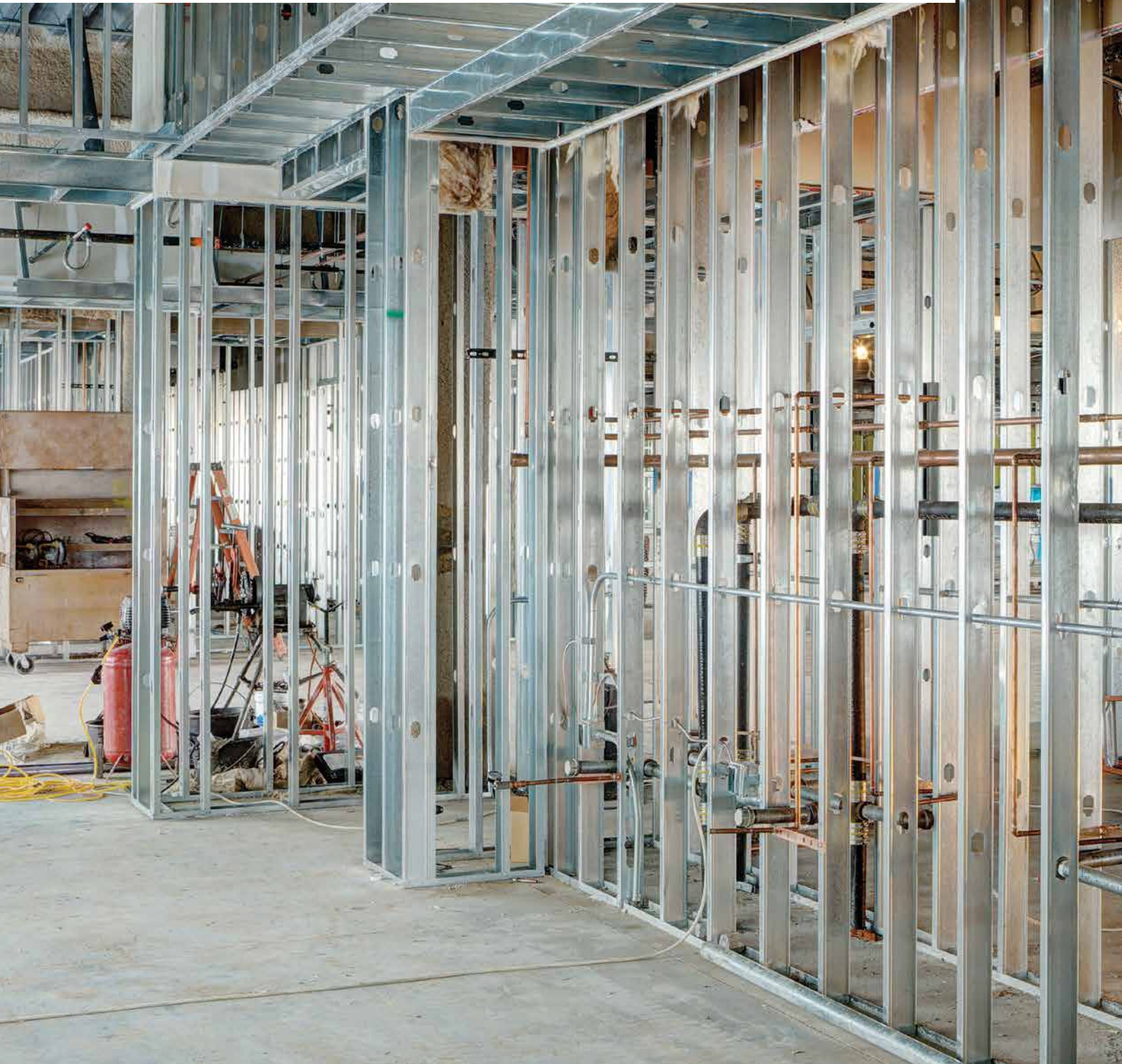

Ramset[®]
DRIVING JOBSITE SPEED



Notes

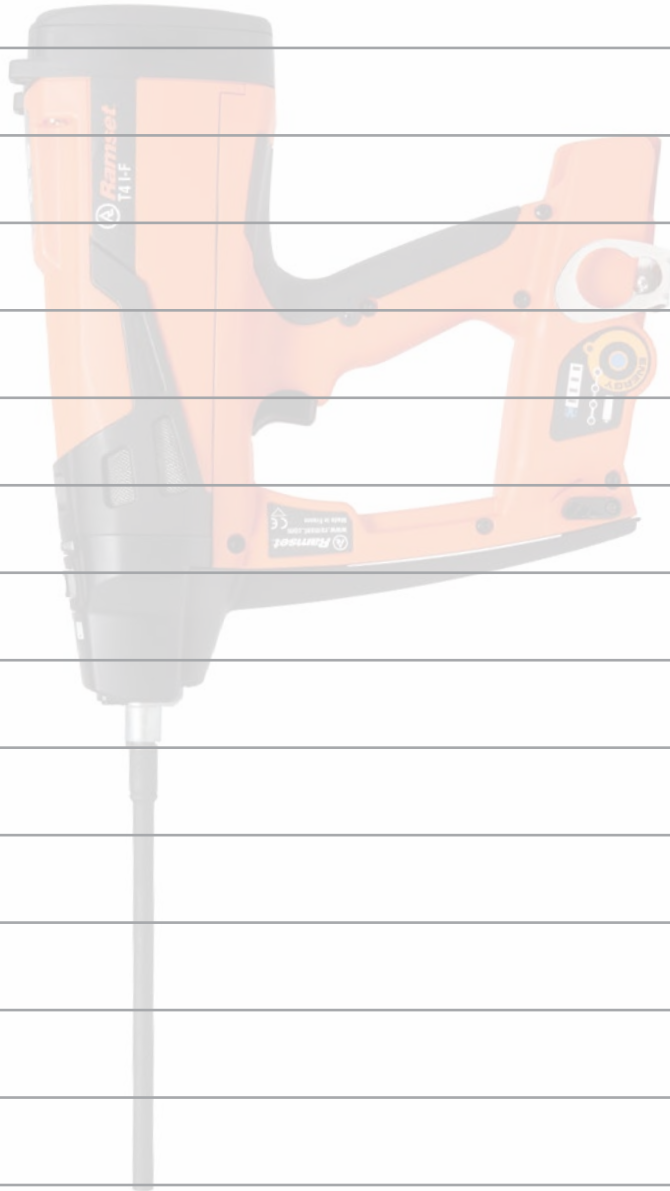









TABLE OF CONTENTS



Tools At A Glance.....	R 4
Introduction to Gas Technology.....	R 6
T4MAG.....	R 8
T4SS Conversion Kit.....	R 10
T3MAG (Discontinued - See T4MAG).....	R 12
NEW! TrakFast - TF1200.....	R 14
T4 I-F Compact.....	R 18
T4 I-F Gas Powered Tool (Discontinued - See T4 I-F Compact).....	R 22
Introduction to Powder Fastening Systems.....	R 25
Training and Certification.....	R 26
RA27.....	R 27
Cobra+.....	R 28
Cobra+ Insulfast.....	R 29
Hammer Shot 22 cal.....	R 30
Mastershot 22 cal.....	R 30
TriggerShot 22 cal.....	R 30
Troubleshooting.....	R 31
Problem Solving Pins.....	R 34
Powder Fasteners.....	R 35
Powder Loads.....	R 37
Suggested Specifications.....	R 38
Performance Data/Submittal Information.....	R 39
TE Performance Data/Submittal Information.....	R 41

	TOOL	DESCRIPTION	TYPICAL BUILDING TRADE	
GAS POWERED TOOLS	 (see page R 8)	T4MAG 45-Pin Magazine Cross Over Technology 2 Year Warranty	Length: 17" Height: 16-1/4" Weight: 8.4 lbs. Maximum Pin Length: 1"	WALLS & CEILINGS
	 (see page R 10)	T3MAG 45-Pin Magazine One Step Fuel Injection Cross Over Technology 2 Year Warranty	Length: 18-1/2" Height: 15" Weight: 9.2 lbs. Maximum Pin Length: 1"	WALLS & CEILINGS
	DISCONTINUED - SEE T4MAG			
	 (see page R 14)	TF1200 Fully Automatic 42-Pin Magazine 1-1/2" Pin Capacity 2 Year Warranty	Length: 17" Height: 15-1/2" Weight: 8.375 lbs. Maximum Pin Length: 1-1/2"	WATERPROOFING WALLS & CEILINGS
	 (see page R 18)	T4 I-F COMPACT Fully Automatic Single Pin Gas Tool Fuel Injection 2 Year Warranty	Length: 20.25" Height: 12.4" Weight: 7.3 lbs. Maximum Pin Length: 8"	INSTALLATION FOR WALLS & CEILINGS FOUNDATION & WATER PROOFING
	 (see page R 22)	T4 I-F Automatic Power Adjustment Single Pin Gas Tool Fuel Injection 2 Year Warranty	Length: 21" Height: 12" Weight: 7.9 lbs.	INSTALLATION FOR WALLS & CEILINGS FOUNDATION & WATER PROOFING
DISCONTINUED - SEE T4 I-F COMPACT				

	TOOL	DESCRIPTION	TYPICAL BUILDING TRADE
.27 CAL STRIP TOOL	 RA27 Fully Automatic Low Velocity Piston Type Fastening Tool 3 Year Warranty (see page R 27)	Part No. RA27 Length: 15" Weight: 5.3 lbs. Muzzle Bushing O.D.: 9/16" Maximum Pin Length: 1-1/2" (2" w/washer)	WALLS & CEILINGS
	 COBRA+ Semi-Automatic Economical 1 Year Warranty (see page R 28)	Part No. COBRA+ Length: 15" Weight: 5.25 lbs. Muzzle Bushing O.D.: 9/16" Maximum Pin Length: 2-1/2" (3" w/Washer)	WALLS & CEILINGS
	 COBRA+ INSULFAST Accessory for Converting Cobra+ into Insulation Fastening Tool (see page R 29)	Part No. COBRAIFKIT Length: 19" Weight: 5.25 lbs. Insulation thickness range: 1" - 2" *Other sizes available on special request	INSTALLATION FOR WALLS & CEILINGS FOUNDATION & WATER PROOFING

.22 CAL SINGLE SHOT TOOLS	Hammer Shot	Master Shot	Trigger Shot
	 Part No. 45000 Application: Basement renovations Maximum Pin Length: 2-1/2" .22 caliber single shot loads: 2, 3, 4 (see page R 30)	 Part No. 45100 Application: Basement renovations applications in concrete and steel Maximum Pin Length: 2-1/2" (3" w/washer) .22 caliber single shot loads: 2, 3, 4 (see page R 30)	 Part No. 45200 Application: Basement renovations Maximum Pin Length: 2-1/2" .22 caliber single shot loads: 2, 3, 4 (see page R 30)

Intro to Gas Technology

ITW saw a challenge: how to create a portable tool that delivered the power of pneumatic tools without the hoses and compressors. In 1991, ITW Paslode conquered the challenge with the revolution of gas-powered technology. The cordless Impulse Finish Nailer delivered the power of pneumatic tools without cluttering job sites.

With the thought of Driving Jobsite Speed while creating a safer work environment, ITW Ramset built upon the Paslode technology and in 1992 introduced the TrakFast to the drywall trade. It forever changed the way the world worked. In 2003, ITW Ramset followed up on the success of the TrakFast with the T3SS which is setting the standard for electrical and mechanical contractors.



Drywall



Electrical



Mechanical

- No Licensing Required
- Fast and Easy to Use
- Quiet—No Recoil
- No Cords or Hoses
- Long Fuel Cell & Battery Life

Gas significantly lowers cost-in-place, reduces stress on the employee, and it's much quieter to use than drilling or powder actuated tools (PATs), so you can work in occupied buildings. There are times when you need the power and accuracy of our PATs—like the speed of our fully automatic RA27 tool, or the work horse, nearly maintenance-free Cobra+ semi-automatic PAT. But constant use of these tools can be noisy and overly jarring on the body.

When the conditions are right, gas is the right choice.

Problem:
"My guys work on block all day long—from electrical boxes to furring. I've tried powder tools and they blow holes in block. What makes the Ramset technology different?"

Solution:
Ramset technology has patented overdrive technology built in to every gas-powered tool. The tool works under the same principal as a combustion engine. A little gas, a little spark and a powerful shot, without the recoil associated with powder.

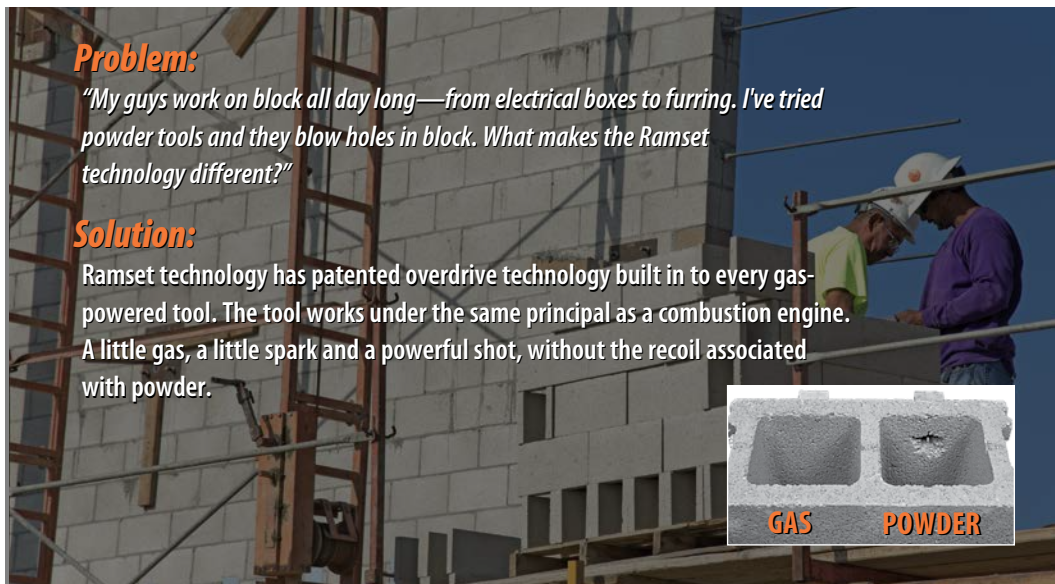



GAS **POWDER**

The industry transitions to gas technology

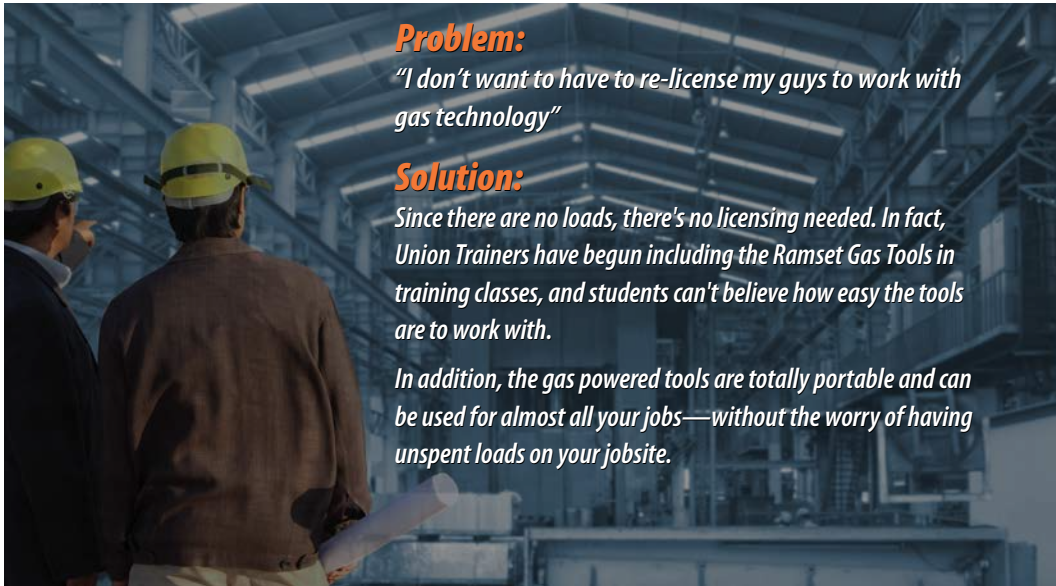

Problem:

"I don't want to have to re-license my guys to work with gas technology"

Solution:

Since there are no loads, there's no licensing needed. In fact, Union Trainers have begun including the Ramset Gas Tools in training classes, and students can't believe how easy the tools are to work with.

In addition, the gas powered tools are totally portable and can be used for almost all your jobs—without the worry of having unspent loads on your jobsite.

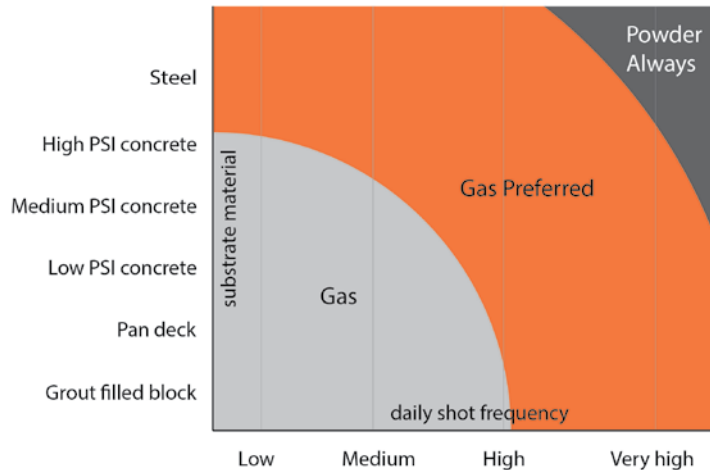

The Inside Story

The patented Ramset technology delivers precisely balanced power eliminating the damage caused by overdrive in PATs.

How it works: As the nosepiece is depressed, a rechargeable battery turns on the fan motor. In less than a second: a precise amount of fuel is injected into the combustion chamber. When the trigger is pulled, a spark creates an explosion that drives the piston into the fastener, and the fastener in the work surface. The action creates a vacuum that pulls the piston back to the start position.

In fact the technology is so precise it won't blow through a pop can.

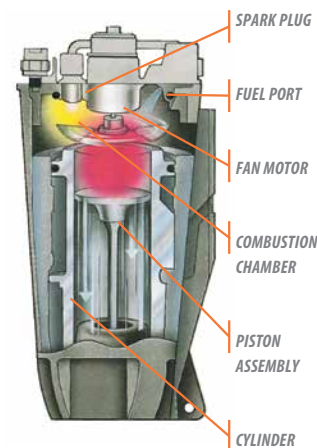

T4MAG

Gas Powered Tool

Gas Technology
 45 Pin Magazine
 Best balanced
 tool available



DESCRIPTION/SUGGESTED SPECIFICATIONS

Automatic Fastening System— THE OPERATOR'S CHOICE—THE PREMIER FASTENING SYSTEM FOR THE COMMERCIAL DRYWALL CONTRACTOR

Ramset's T4MAG is the best-balanced tool available and is easy to use overhead. With 30% more power to work in the toughest concrete, this tool will drive your job site productivity and result in lower user fatigue and downtime.

ADVANTAGES

- Higher stick rate than industry standard
- 30% more power to work in the toughest concrete
- Drives pins flush to create full embedment
- Lower pushdown force and shorter travel distance decrease user fatigue
- Reduced jamming, resulting in less downtime on the job
- Superb balance leads to optimal user experience

T4MAG Increase Your Range with Overhead Power

The Power of the T4MAG allows you to consistently shoot where no other gas tool has gone before. The .125 diameter pin is specifically engineered to work in the toughest concrete and steel where other pins cannot perform. The new T4MAG system delivers power that rivals other gas and powder systems.

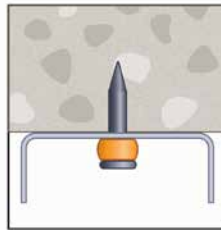

Setting aggregate is the biggest reason for overhead pin failure.

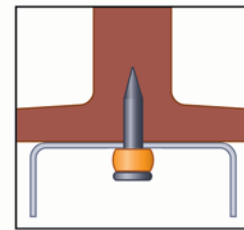

With the T4's 1/2" steel pin you can even shoot into the web of steel.

SPECIFICATIONS

Part number: T4MAG

Length: 17"

Height: 16-1/4"

Weight: 8.4 pounds

Battery capacity: 3,500 shots

Magazine capacity: 45 pins

Maximum pin length: 1"

Operating temperatures: -15°C - 48°C

MOST COMMON FASTENERS

T4MAG Fuel/Pin Pack

510 PINS AND 1 FUEL CELL PER INNER PACK

PART NUMBER	SHANK LENGTH IN. (mm)	DESCRIPTION (Comes with T4 Fuel)
T4012S	1/2 (12.7)	T4 1/2" Plated premium steel pin
T4034S*	3/4 (19.1)	T4 3/4" Plated step shank concrete pin
T4100	1 (25.4)	T4 1" Plated concrete pin

• Collated on the point instead of on the head to significantly reduce pin jams

Shank diameter = .125 *Shank diameter = .104 / .125 Head diameter = .250

APPLICATIONS

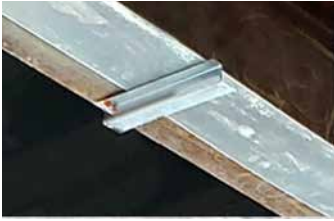

Track to Steel



Track to Concrete



Deep Leg Track

APPROVALS/LISTING

ICC ESR 1955 - Fasteners

COLA RR-22668 - Fasteners

TOOL ACCESSORIES



Part No. T4FUEL
Fuel Cell - T4
Qty: 12 (4-3packs)



Part No. 018151
Battery - T4MAG
Qty: 1



Part No. 018152
Battery Charger - T4MAG
Qty: 1





T4SS Conversion Kit



T4SS - Conversion Kit Convert your T4MAG

ADVANTAGES

- Tapered Design: The tool is engineered to reach into tight areas
- Adjustable depth of drive for optimal performance
- Auto shut-off/on avoids drain on lithium-ion battery
- Smaller 510-shot fuel cell to keep better track of the day's progress
- Fuel and battery gauges eliminate interruptions
- Scaffold hook keeps your tool within reach

	Higher stick rate than industry standard		Easy push-down force decreases user fatigue
	30% more power to work in hard concrete		Preassembled fasteners for optimal job performance and easy ordering
	Drives pins flush to create full embedment		Superb balance leads to optimal user experience

SELECTION CHART

One Hole Strap



Used to attach conduit or armored cable to concrete. Fastener pre-assembled to a 16 gage conduit strap. 100 per jar, 3/8" 200 per jar and 1-1/4" 25 per jar.

PART NUMBER	SHANK DIAMETER	HEAD DIAMETER	DESCRIPTION
38HSMP034	.104/.125	.300	3/8" Hole strap with 3/4" plated pin
12HSMP034	.104/.125	.300	1/2" Hole strap with 3/4" plated pin
34HSMP034	.104/.125	.300	3/4" Hole strap with 3/4" plated pin

Ceiling Clip Assembly



Pre-assembled Ceiling Clip. Plated 14 gage clip. 100 per jar.

PART NUMBER	SHANK DIAMETER	HEAD DIAMETER	DESCRIPTION
34CLIP	.104/.125	.300	3/4" Ceiling Clip Assembly

Tie Strap Holder



Used to install temporary lighting and secure low voltage cable to concrete, uses a standard cable tie up to 3/8" in width. Fastener pre-assembled to an 22 gage tie strap holder. 50 per jar.

PART NUMBER	SHANK DIAMETER	HEAD DIAMETER	DESCRIPTION
TSHMP034	.104/.125	.300	Tie strap holder with 3/4" plated pin

PIN SPECIFICATIONS

Made from AISI 1060-1065 steel Austempered to a core hardness of 52-56 Rc

Typical tensile strength: 270,000 psi

Typical shear strength: 162,000 psi

Standard finish

- Proprietary black
- Mechanical zinc plate to a minimum thickness of .0002 meets requirements of ASTM 8695
- Electroplated zinc with yellow chromate

APPROVALS/LISTING

ICC Evaluation Service, Inc.

#ESR 1955 T3 Fasteners

APPLICATIONS

Mechanical Trades

Electrical Trades

Plumbing Trades

Fasteners in Concrete

FASTENER PART NUMBER	SHANK DIA. (INCH)	MINIMUM PENETRATION (INCH)	INSTALLED IN STONE AGGREGATE CONCRETE CONCRETE COMPRESSIVE STRENGTH ALLOWABLE LOAD – <i>Ultimate Load</i>						HOLLOW BLOCK Grade N, Type 1	
			4000 PSI		6000 PSI		3000 PSI Lightweight LOWER FLUTE		FACE SHELL Min 1-1/4" face thickness	
			TENSION (LBS)	SHEAR (LBS)	TENSION (LBS)	SHEAR (LBS)	TENSION (LBS)	SHEAR (LBS)	TENSION (LBS)	SHEAR (LBS)
MP034TH*	0.125	5/8	78 426	80 574	62 308	----	72 361	242 1210	133 691	----
		3/4	104 593	195 977	132 658	206 1057	93 470	288 1442	84 444	87 446
34CLIP	0.104/ .125	5/8	62 310	----	106 528	----	44 220	----	----	----
38HSMP034, 12HSMP034 34HSMP034, TSHMP034	0.104/ .125	5/8	60 357	117 587	107 533	191 957	54 269	230 1150	71 357	123 613

*MP034TH is no longer available

T3MAG

Gas Powered Tool

Gas Technology
 45 Pin Magazine
 One Step Fuel Injection



DESCRIPTION/SUGGESTED SPECIFICATIONS

Automatic Fastening System—

THE PREMIER FASTENING SYSTEM FOR THE COMMERCIAL DRYWALL CONTRACTOR

The nose of the T3 has been specifically engineered to allow the tool to easily reach into 1-5/8" x 2" deep track at any angle. The newly designed nosepiece, point collation, and patented pin-feed mechanism allows for easy fastening without jamming.



Point Collation virtually eliminates jams.

The T3 is ergonomically balanced for less operator fatigue. No more fumbling to get the tool into position with the "grip it & flip it" design.

ADVANTAGES

- Higher stick rate (.125 diameter)
- 25% more power
- Easy push down force
- Deep leg track capability
- 45-pin magazine capability
- Newly designed fitted dust shield
- Battery charger provides constant charging even with low voltage drops
- 2 Year Warranty (6 months on wearable parts).

T3MAG Increase Your Range with Overhead Power

The Power of the T3MAG allows you to consistently shoot where no other gas tool has gone before. The .125 diameter pin is specifically engineered to work in the toughest concrete and steel where other pins cannot perform. The new T3MAG system delivers power that rivals other gas and powder systems.

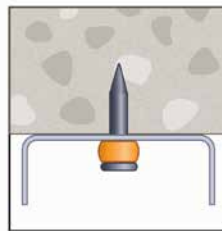

Setting aggregate is the biggest reason for overhead pin failure.

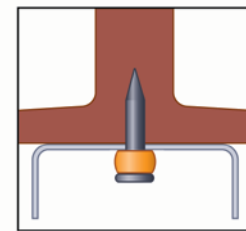

With the T3's 1/2 steel pin you can even shoot into the web of steel.

SPECIFICATIONS

Part No. T3MAG
 Length: 18-1/2"
 Height: 15"
 Weight: 9.2 lbs.
 Pin Guide O.D.: 590
 Fuel cell: 1000 shots
 Battery (charged): 3000 shots

SELECTION CHART

T3MAG Fuel/Pin Pack

1,000 PINS AND 1 FUEL CELL PER BOX.



PART NUMBER	SHANK LENGTH IN.	SHANK LENGTH (mm)	DESCRIPTION (comes with T3 fuel cell)
T3012S	1/2	(12.7)	1/2" Plated premium steel pin
T3034B	3/4	(19.1)	3/4" Black concrete pin
T3034S*	3/4	(19.1)	3/4" Plated step shank pin
T3100	1	(25.4)	1" Plated concrete pin=

Shank diameter = .125 *Shank diameter = .104 / .125
 Head diameter = .250

APPLICATIONS



Perfect for top track and deep leg track applications.



Shoot directly into the web of steel effortlessly.



Even though the T3 has enough power to fasten into hard concrete and steel it still will not blow through hollow block.



Perfect for hat channel applications.

APPROVALS/LISTING

ICC ESR 1955 - Fasteners

COLA RR-22668 - Fasteners

TOOL ACCESSORIES



Part No. T3FUEL
Fuel Cell—T3SS
Qty: 12 (6–2 packs)



Part No. B0092
Battery—T3SS
Qty: 1



Part No. 906001 (T3MAG v2)
Part No. B0237 (T3MAG)
Magnetic Disc Probe
Qty: 1

Part No. 219503
T3 Double Battery
Charger
Qty: 1

Part No. 906014
T3 Single Battery
Charger
Qty: 1

PERFORMANCE TABLE

Gas Fasteners in Steel

PART NUMBER	SHANK DIA. (INCH)	TYPE OF SHANK	INSTALLED IN A36 STRUCTURAL STEEL – STEEL THICKNESS INCHES									
			ALLOWABLE LOAD – <i>Ultimate Load</i>									
			3/16 (.1875)		1/4 (.250)		3/8 (.375)					
		TENSION (LBS)	SHEAR (LBS)	TENSION (LBS)	SHEAR (LBS)	TENSION (LBS)	SHEAR (LBS)					
T3012S/ T4012S	0.125	TAPER SMOOTH	-----	-----	237	<i>1184</i>	356	<i>1782</i>	189	<i>943</i> ¹⁰	392	<i>1960</i> ⁷

Note 1: ALLOWABLE loads are shown in the **LARGE BOLD** font, *Ultimate* loads are shown in *smaller italic* font. **Note 2:** Testing conducted in accordance with ICC AC70 & ASTM E1190. **Note 3:** Safety factors are based on coefficient of variation. In accordance with ICC AC70, the safety factor will be no less than 5. **Note 4:** Cyclic, fatigue, shock loads and other design criteria may require a different safety factor. **Note 5:** Job site testing may be required to determine actual job site values. **Note 6:** Values shown are for fastenings that have the entire pointed end of the fastener driven through the steel plate; except as noted below. **Note 7:** Fastener penetration is .31" minimum. **Note 8:** Fastener penetration is .29" minimum. **Note 9:** Fastener penetration is .27" minimum. **Note 10:** Fastener penetration is .25" minimum. **Note 11:** For Sl: 1 lbf = 4.448 N, 1 inch = 25.4 mm, 1 ksi = 6.89MPa

Collated Gas Fasteners in Concrete

PART NUMBER SERIES	SHANK DIAMETER (INCH)	MINIMUM PENETRATION (INCH)	INSTALLED IN STONE AGGREGATE CONCRETE – CONCRETE COMPRESSIVE STRENGTH											
			ALLOWABLE LOAD – <i>Ultimate Load</i>											
			2000 PSI		3000 PSI		4000 PSI							
		TENSION (LBS)	SHEAR (LBS)	TENSION (LBS)	SHEAR (LBS)	TENSION (LBS)	SHEAR (LBS)							
T3/T4 Straight Shank	0.125	5/8	83	<i>414</i>	109	<i>611</i>	-----	-----	78	<i>426</i>	80	<i>574</i>		
		3/4	107	<i>541</i>	156	<i>855</i>	-----	-----	104	<i>593</i>	195	<i>977</i>		
PART NUMBER SERIES	SHANK DIAMETER (INCH)	MINIMUM PENETRATION (INCH)	INSTALLED IN STONE AGGREGATE CONCRETE – CONCRETE COMPRESSIVE STRENGTH											
			ALLOWABLE LOAD – <i>Ultimate Load</i>											
			3000 PSI LIGHT WEIGHT CONCRETE		3000 PSI LIGHT WEIGHT CONCRETE WITH METAL DECK		HOLLOW CONCRETE MASONRY UNITS (CMU) ANY LOCATION							
		TENSION (LBS)	SHEAR (LBS)	TENSION (LBS)	SHEAR (LBS)	TENSION (LBS)	SHEAR (LBS)							
T3/T4 Straight Shank	0.125	5/8	84	<i>418</i>	108	<i>540</i>	72	<i>361</i>	242	<i>1210</i>	20 ⁹	<i>243</i>	34	<i>264</i>
		3/4	108	<i>540</i>	173	<i>864</i>	93	<i>470</i>	288	<i>1442</i>	-----	-----	-----	-----

Note 1: ALLOWABLE loads are shown in the **LARGE BOLD** font, *Ultimate* loads are shown in *smaller italic* font. **Note 2:** Testing conducted in accordance with ICC AC70 & ASTM E1190. **Note 3:** Safety factors are based on coefficient of variation. In accordance with ICC AC70, the safety factor will be no less than 5. **Note 4:** Values shown in concrete are for the fastener only. Connected members must be investigated separately. **Note 5:** Cyclic, fatigue, shock loads, and other design criteria may require a different safety factor. **Note 6:** Job site testing may be required to determine actual job site values. **Note 7:** Minimum edge distance in concrete is 3 inches unless otherwise approved. **Note 8:** For Sl: 1 lbf = 4.448 N, 1 inch = 25.4 mm, 1 ksi = 6.89MPa. **Note 9:** T3 straight shank allowable tension value in face shell of hollow CMU is 133 lbs.

TrakFast

TF1200 Gas Powered Tool

Fully Automatic
1-1/2" Pin Capacity
42 Pin Magazine
Capacity

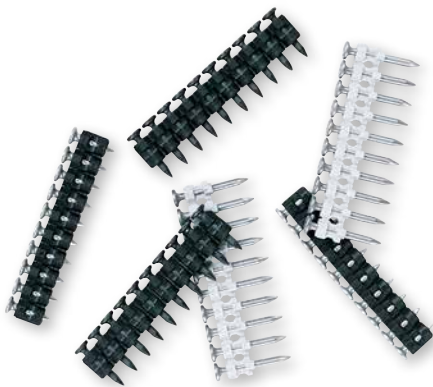

DESCRIPTION/SUGGESTED SPECIFICATIONS

Automatic Fastening System—

Since its introduction in 1991, TrakFast has been the tool of choice for both interior and exterior contractors. The TrakFast Automatic Fastening System fastens all types of track, from standard track to hat channel, deep leg, Z, and J channel. Contractors continue to report tremendous savings when using TrakFast for high production fastening. They have learned that TrakFast's actual cost in place beats all other systems. The



Fastening System Productivity

In the time it takes
you to drive two pins
with a powder tool,
you can drive up to
10 pins with TrakFast!

increased speed and productivity of TrakFast allows the contractor to bid more competitively, complete the job sooner and move on to the next job. Anyone can use TrakFast—just load the pins and fire. It's that easy!

ADVANTAGES

- **SPEED** Three to five times faster than powder tools. 42-pin magazine reduces loading time.
- **EASY TO USE** Tool automatically resets piston. No recoil, tool absorbs shock resulting in less operator fatigue.
- **NO LICENSING REQUIRED** Unlike powder-actuated tools, no licensing is needed.
- **NO CHANGING LOADS** TrakFast uses a fuel cell, not a load. No need to inventory different colored loads.
- **NARROW NOSE AND PROFILE** Allows tool to reach inside deep leg track (1-5/8" wide x 2" high).
- **2 Year Warranty** (6 months on wearable parts).

TrakFast's power comes from the battery and fuel cell

The 6-volt rechargeable Ni-CD battery can drive approximately 3000 shots per charge. The clean burning fuel cell can drive over 1000 pins and keeps the tool cleaner than powder actuated tools.



MOST COMMON FASTENERS

PIN #	PIN LENGTH		MOST COMMON APPLICATION
	IN.	MM	
FPPSP916	9/16	14.3	Track to steel
FPP034B	3/4	19.1	Track to concrete
FPP114	1-1/4	31.8	Membering to concrete

See page R 14 for all fasteners.

APPLICATIONS



Waterproofing to concrete



Track to concrete



Track to steel

SPECIFICATIONS

Part No. TF1200

Length: 17"

Height: 15-1/2"

Weight: 8.375 lbs.

Maximum Capacity: 42 pins

Maximum cycles/second: 2

Fuel cell: 1000 shots

Battery (charged): 3000 shots

APPROVALS/LISTING

ICC ESR-2579 - TrakFast Fasteners (Note: This report replaces ER-5001)

COLA RR-25264 - TrakFast Fasteners (City of LA)



TrakFast ICC (ICBO) ER-5001 is the only approval that allows you to fasten into any location on a hollow block wall and won't blow away block like a powder tool.

TOOL ACCESSORIES



Part No. 4821
Fuel Cell—TrakFast



Part No. B0092
Battery—T3SS
Qty: 1



Part No. 100041LA
Disc Holding Probe
(for TF1200 Telescoping Nose)
Qty: 1



SLIP-OVER CUP
Part No. 7405161
For Cosella Dorken
(DELTA-MS) Plugs
Qty: 1



Part No. LD100
Plated 1" Lathing Disc 22g
Qty: 1,000 per box

Part No. 219503
T3 Double Battery
Charger
Qty: 1

Part No. 906014
T3 Single Battery
Charger
Qty: 1

TRAKFAST GAS TOOL FASTENERS

Ramset collated Gas Tool Fasteners are specifically engineered for optimal performance in Ramset Gas Power Tools using fastener magazines

SELECTION CHART

TrakFast Standard Fuel /Pin Pack

STRAIGHT SHANK



For high volume, repetitive fastenings to concrete and steel such as drywall track to concrete. 1,000 pins and 1 fuel cell per box.

PART NUMBER	SHANK LENGTH IN. (mm)	DESCRIPTION
FPP034B	3/4 (19.1)	3/4" Black pin
FPP114	1-1/4 (31.8)	1-1/4" Plated pin

Shank diameter = .109 Head diameter = .250

TrakFast Premium Fuel /Pin Pack

STEP SHANK



For high volume, repetitive fastenings to hard concrete and hard steel such as drywall track to hard concrete and steel. 1,000 pins and 1 fuel cell per box.

PART NUMBER	SHANK LENGTH IN. (mm)	DESCRIPTION
FPPSP916	9/16 (14.3)	9/16" Gold pin

Shank diameter = .104 / .118 Head diameter = .250

Trakfast Breakaway Strip Fuel/Pin

STRAIGHT SHANK



For high volume, repetitive fastenings to concrete such as wood furring to concrete. 1,000 pins and 1 fuel cell per box.

PART NUMBER	SHANK LENGTH IN. (mm)	DESCRIPTION
FPP112T	1-1/2 (38.1)	1-1/2" Plated pin

Shank diameter = .109 Head diameter = .250

Ramset fasteners may be specified by their type or catalog number to satisfy fastening requirements.

PIN SPECIFICATIONS

Made from AISI 1060-1065 steel. Austempered to a core hardness of 52-56 Rc
 Typical tensile strength: 270,000 psi
 Typical shear strength: 162,000 psi
 Standard finishes
 - Proprietary black
 - Mechanical zinc plate to a minimum thickness of .0002 meets requirements of ASTM B695
 - Electroplated zinc with yellow chromate

APPROVALS/LISTING

ICC Evaluation Service, Inc.

#ESR-2579 TrakFast Pins

City of Los Angeles

#RR-25264 TrakFast pins

PERFORMANCE TABLES
Collated Gas Fasteners in Concrete

PART NUMBER SERIES	SHANK DIAMETER (INCH)	MINIMUM PENETRATION (INCH)	INSTALLED IN STONE AGGREGATE CONCRETE – CONCRETE COMPRESSIVE STRENGTH								
			ALLOWABLE LOAD – <i>Ultimate Load</i>								
			2000 PSI		3000 PSI		4000 PSI				
		TENSION (LBS)	SHEAR (LBS)	TENSION (LBS)	SHEAR (LBS)	TENSION (LBS)	SHEAR (LBS)				
FPP - Straight Shank	0.109	5/8	60 <i>434</i>	55 <i>546</i>	55 <i>453</i>	75 <i>615</i>	55 <i>472</i>	95 <i>685</i>			
		3/4	60 <i>595</i>	80 <i>650</i>	55 <i>583</i>	95 <i>699</i>	55 <i>571</i>	115 <i>749</i>			
FPPSP - Step Shank	0.104/0.118	3/4	-----	-----	-----	-----	-----	51 <i>256</i>	83 <i>418</i>		

PART NUMBER SERIES	SHANK DIAMETER (INCH)	MINIMUM PENETRATION (INCH)	INSTALLED IN STONE AGGREGATE CONCRETE – CONCRETE COMPRESSIVE STRENGTH							
			ALLOWABLE LOAD – <i>Ultimate Load</i>							
			3000 PSI LIGHT WEIGHT CONCRETE		3000 PSI LIGHT WEIGHT CONCRETE WITH METAL DECK		HOLLOW CONCRETE MASONRY UNITS (CMU) ANY LOCATION			
		TENSION (LBS)	SHEAR (LBS)	TENSION (LBS)	SHEAR (LBS)	TENSION (LBS)	SHEAR (LBS)			
FPP - Straight Shank	0.109	5/8	35 <i>234</i>	55 <i>403</i>	30 <i>239</i>	205 <i>1025</i>	35 <i>347</i>	50 <i>435</i>		
		3/4	80 <i>630</i>	115 <i>756</i>	40 <i>330</i>	235 <i>1284</i>	-----	-----	-----	-----
FPPSP - Step Shank	0.104/0.118	3/4	-----	-----	-----	-----	36 <i>184</i>	58 <i>290</i>		

Note 1: ALLOWABLE loads are shown in the **LARGE BOLD** font, *Ultimate* loads are shown in *smaller italic* font. **Note 2:** Testing conducted in accordance with ICC AC70 & ASTM E1190. **Note 3:** Safety factors are based on coefficient of variation. In accordance with ICC AC70, the safety factor will be no less than 5. **Note 4:** Values shown in concrete are for the fastener only. Connected members must be investigated separately. **Note 5:** Cyclic, fatigue, shock loads, and other design criteria may require a different safety factor. **Note 6:** Job site testing may be required to determine actual job site values. **Note 7:** Minimum edge distance in concrete is 3 inches unless otherwise approved. **Note 8:** For SI: 1 lbf = 4.448 N, 1 inch = 25.4 mm, 1 ksi = 6.89MPa.

Gas Fasteners in Steel

PART NUMBER	SHANK DIA. (INCH)	TYPE OF SHANK	INSTALLED IN A36 STRUCTURAL STEEL – STEEL THICKNESS INCHES							
			ALLOWABLE LOAD – <i>Ultimate Load</i>							
			3/16 (.1875)		1/4 (.250)		3/8 (.375)			
		TENSION (LBS)	SHEAR (LBS)	TENSION (LBS)	SHEAR (LBS)	TENSION (LBS)	SHEAR (LBS)			
FPPSP916	0.104/.118	SMOOTH	-----	-----	148 <i>744</i>	157 <i>787</i>	166 <i>832</i> ¹	157 <i>787</i> ¹		

Note 1: ALLOWABLE loads are shown in the **LARGE BOLD** font, *Ultimate* loads are shown in *smaller italic* font. **Note 2:** Testing conducted in accordance with ICC AC70 & ASTM E1190. **Note 3:** Safety factors are based on coefficient of variation. In accordance with ICC AC70, the safety factor will be no less than 5. **Note 4:** Cyclic, fatigue, shock loads and other design criteria may require a different safety factor. **Note 5:** Job site testing may be required to determine actual job site values. **Note 6:** Values shown are for fastenings that have the entire pointed end of the fastener driven through the steel plate; except as noted below. **Note 7:** Fastener penetration is .31" minimum. **Note 8:** For SI: 1 lbf = 4.448 N, 1 inch = 25.4 mm, 1 ksi = 6.89MPa

NEW! T4 I-F
Compact Gas
Powered Tool

Insulation Fastening
Innovation In A
Smaller, Lighter,
More Powerful
Design.



SPECIFICATIONS

- Part No. T4 IF-CT
- Length: 20.25"
- Height: 12.4"
- Weight: 7.3 lbs.
- Impact Force: 95J
- Fuel Cell: up to 600 shots
- Battery (Charged): up to 10,000 shots

DESCRIPTION/SUGGESTED SPECIFICATIONS

Fully Automatic Fastening System—
IMPROVE YOUR PRODUCTIVITY - WORK FASTER THAN EVER BEFORE

The T4 I-F System is 4 times faster than the traditional stick pin installation method. It allows the installer to attach insulation in one simple step without the use of adhesives or cutting spindle insulation anchors anymore. The latest tool in the T4 line up provides 19% more power, 7% less pushdown force, 10,000 shot battery life, all the while weighing 8% lighter than the previous model.

ADVANTAGES

- Fasten the insulation directly to concrete, hollow block and steel studs. No need to glue and stickpin insulation anchors anymore.
- The fastening is constant and clean looking.
- Light weight of 7.3lbs means lower operator fatigue.
- The tool allows you to fasten the insulation in tight spaces through pipes and sprinkler systems.
- The T4FUEL can shoot approx. 600 shots before replacing.
- The system can be used year round; unlike stick pins, you won't be restricted by cold temperature or wet surfaces.
- Operating temperature from -15 C to 49 C

APPLICATIONS



- Exterior Walls - Insulation to steel
- Exterior Walls - Insulation to concrete
- Foundation Walls
- Parking Garages
- Heated Floors
- Balcony Insulation
- Block Walls
- Ceiling Acoustical Insulation



PERFORMANCE TABLE

STEEL STUDS

FASTENERS	ALLOWABLE/ULTIMATE PULLOUT LOAD LBS (kN)			
	22GA	20GA	18GA	16GA
T4IFS-100 - T4IFS-600	20/120 (0.09/0.53)	33/200 (0.15/0.89)	46/280 (0.20/1.25)	60/360 (0.27/1.60)

CONCRETE

FASTENERS	CONCRETE STRENGTH PSI (Mpa)	ALLOWABLE/ULTIMATE TENSION LOADS Lbs (kN)
T4IFC-100 - T4IFC-600	3600-6500 (25-45)	35/211 (0.15/0.94)

HOLLOW CONCRETE BLOCK

FASTENERS	ALLOWABLE/ULTIMATE TENSION LOADS Lbs (kN)
T4IFC-100 - T4IFC-600	35/184 (0.15/0.82)

TOOL ACCESSORIES



Part No. 019336
Battery-T4IF
Qty: 1



Part No. 018866
Battery Charger - T4IF
Qty: 1



Part No. T4FUEL
Fuel Cell - T4
Qty: 12 (4-3 packs)

Part No. 018578
Nose Piece - T4IF
Qty: 1

SELECTION CHART

FASTENERS FOR STEEL STUDS

PART NUMBER	DESCRIPTION	INSULATION THICKNESS	BOX QTY
T4IFS-100	1" Insulation Fastener w/fuel	1" (25 mm)	500
T4IFS-112	1-1/2" Insulation Fastener w/fuel	1-1/2" (38 mm)	500
T4IFS-200	2" Insulation Fastener w/fuel	2" (50 mm)	500
T4IFS-212	2-1/2" Insulation Fastener w/fuel	2-1/2" (63 mm)	500
T4IFS-300	3" Insulation Fastener w/fuel	3" (75 mm)	500
T4IFS-312	3-1/2" Insulation Fastener w/fuel	3-1/2" (89 mm)	500
T4IFS-400	4" Insulation Fastener w/fuel	4" (100 mm)	500
T4IFS-500	5" Insulation Fastener w/fuel	5" (125 mm)	500
T4IFS-600	6" Insulation Fastener w/fuel	6" (150 mm)	400
T4IFS-700	6" Insulation Fastener w/fuel	7" (175 mm)	300
T4IFS-800	8" Insulation Fastener w/fuel	8" (200 mm)	300
T4IF	T4 I-F Insulation Tool (6" Capacity)		1
T4IF-CT	T4 I-F Compact Insulation Tool (8" Capacity)		1

FASTENERS FOR CONCRETE AND CMU

PART NUMBER	DESCRIPTION	INSULATION THICKNESS	BOX QTY
T4IFC-100	1" Insulation Fastener w/fuel	1" (25 mm)	500
T4IFC-112	1-1/2" Insulation Fastener w/fuel	1-1/2" (38 mm)	500
T4IFC-200	2" Insulation Fastener w/fuel	2" (50 mm)	500
T4IFC-212	2-1/2" Insulation Fastener w/fuel	2-1/2" (63 mm)	500
T4IFC-300	3" Insulation Fastener w/fuel	3" (75 mm)	500
T4IFC-312	3-1/2" Insulation Fastener w/fuel	3-1/2" (89 mm)	500
T4IFC-400	4" Insulation Fastener w/fuel	4" (100 mm)	500
T4IFC-412	4-1/2" Insulation Fastener w/fuel	4-1/2" (114 mm)	500
T4IFC-500	5" Insulation Fastener w/fuel	5" (125 mm)	500
T4IFC-600	6" Insulation Fastener w/fuel	6" (150 mm)	400
T4IFC-700	7" Insulation Fastener w/fuel	7" (175 mm)	300
T4IF	T4 I-F Insulation Tool (6" Capacity)		1
T4IF-CT	T4 I-F Compact Insulation Tool (8" Capacity)		1

T4 I-F FASTENERS

INTEGRATED THERMAL CAP

For improved thermal efficiency and aesthetics

FLANGES to ensure the insulation remains perfectly in place, the insulation panel won't flip around during the fastening process

SPECIALLY SHAPED SHAFT – Reduces friction and force required to insert fastener into insulation

POINT designed to pierce most difficult insulation material with little effort

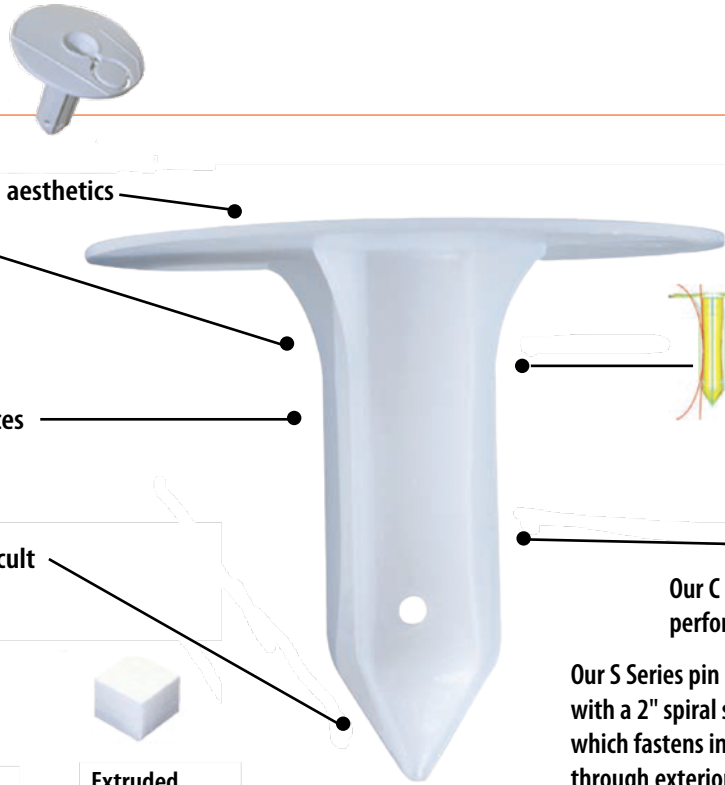

Engineered curved design limits insulation compression which enables full thermal efficiency



Our C Series pin provides exceptional performance in the hardest concrete.

Our S Series pin is equipped with a 2" spiral steel stud pin which fastens insulation sheathing to exterior steel studs in one simple action.



The T4 I-F Fastener™ will not spall the hollow block like powder actuated fasteners.



Damaged insulation by wind loads using stick pin fasteners. T4 I-F Fasteners™ eliminate this problem.

FASTENER SPECIFICATIONS

- Pin Material: Heat treated carbon steel
- Pin Finish: Mechanical Zinc Plated
- Washer Material: High Density Polyethylene (HDPE)
- 2-3/8" Holding Diameter
- Made in Canada
- The fastener assembly is clearly branded Ramset along with the length of the fastener assembly



THERMO BRIDGING

Thermal Performance of Building Envelope Assemblies

In buildings, when insulating material is interrupted by a highly conductive material, thermal bridging takes place. Examples of thermal bridges include steel pins that interrupt the continuity of batt insulation and go through heavily insulated exterior walls. Simply put, thermal bridges occur where differences in material thermal conductivities result in significant lateral heat flow; e.g. heat flowing along the surface of a wall and then flowing through the wall via a steel pin.

The Calculations performed by the Advanced Thermal/Fluids Optimization, Modeling and Simulation (ATOMS) Laboratory, Department of Mechanical & Industrial Engineering, University of Toronto show that the Ramset T4 I-F is over 99% efficient whereas the stick pins can downgrade the efficiency by more than 10%.

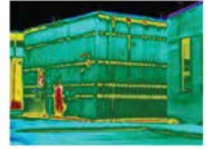

Suggested Specification

The fasteners used to attach Insulation (Rockwool, Expanded Polystyrene and Extruded Polystyrene) into Solid Masonry, Hollow Concrete Block and Steel Studs shall be a Ramset T4 I-F Fastener. The T4 I-F Fastener shall be fastened using the Ramset T4 I-F Gas Tool. The T4 I-F Fastener is made from High Density Polyethylene (HDPE) plastic and has a holding diameter of 2-3/8" (60mm) with the Ramset logo marking.

		Insulation Thickness					
		1 in	2 in	3 in	4 in	5 in	6 in
Reference	U – Factor (W/m ² °C)	1.1786	0.7122	0.5103	0.3976	0.3257	0.2758
	Efficiency (%)	100.00%	100.00%	100.00%	100.00%	100.00%	100.00%
Stick Pin	U – Factor (W/m ² °C)	1.2422	0.7706	0.5597	0.4397	0.3621	0.3078
	Efficiency (%)	94.88%	92.42%	91.17%	90.43%	89.94%	89.59%
InsulFast™	U – Factor (W/m ² °C)	1.1845	0.7162	0.5132	0.3999	0.3276	0.2773
	Efficiency (%)	99.50%	99.45%	99.44%	99.43%	99.42%	99.42%

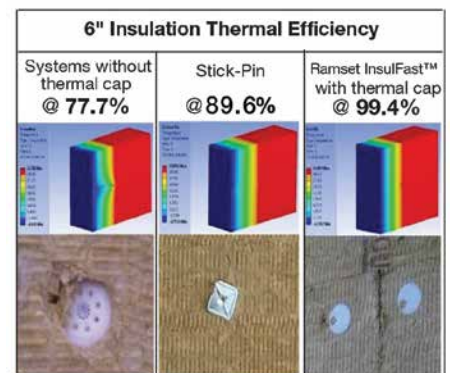

These thermal bridges contribute to a multitude of problems, including, but not limited to:

- Added energy use during heating and cooling seasons
- Interior surface condensation which leads to:
 - ° High humidity levels that can lead to unusual concentrations of airborne contaminants and microbial growth
 - ° Rusting issues that can damage the structure

T4 I-F Compact Overview



Depth of drive button with 2 positions :
DOD mini & DOD maxi

Operating temp.: -15 C to 49 C

Light-weight: Only 3.3kg with battery

Compact & light-weight lithium battery provides 10,000 shots per charge

Compact fuel cell (T4FUEL) provides approx. 600 shots

Larger gauges for battery and gas

Bi-function hook 180° rotative :
Belt and Scaffold positions

T4 I-F Gas Powered Tool

Cordless Gas Nailer for Insulation



SPECIFICATIONS

Part No. T4 IF

Length: 21"

Height: 12"

Weight: 7.9 lbs.

Pin Guide O.D.: 590

Fuel cell: 500 shots

Battery (charged): 3000 shots

DISCONTINUED - SEE T4I-F COMPACT

DESCRIPTION/SUGGESTED SPECIFICATIONS

Fully Automatic Fastening System—

IMPROVE YOUR PRODUCTIVITY - WORK FASTER THAN EVER BEFORE

The T4 I-F is a fully automatic tool that shoots up to 1000 shots per hour. With low push down force (4.5kg)- allows users to work faster, easier and with less fatigue. The Start & Go System provides energy saving with "self cut-off" when not used for 1 minute.

ADVANTAGES

- Cordless technology – 6 x faster than anchoring & 2 x faster than PAT
- Wide range of fasteners for 1"- 6" insulation thickness
- Low noise & vibration level
- Low thermal bridge – no spot stains or dimples
- Low actuation force – work faster, easier & less fatigue
- LED display showing remaining fuel & battery power
- Start & Go System allows for 3000 shots per charge

APPLICATIONS



Exterior Walls - Insulation to steel

Exterior Walls - Insulation to concrete

Foundation Walls

Parking Garages

Heated Floors

Balcony Insulation

Block Walls

Ceiling Acoustical Insulation



PERFORMANCE TABLE

STEEL STUDS

FASTENERS	ALLOWABLE/ULTIMATE PULLOUT LOAD LBS (kN)			
	Steel Gauge	22GA	20GA	18GA
T4IFS-100 - T4IFS-600	20/120 (0.09/0.53)	33/200 (0.15/0.89)	46/280 (0.20/1.25)	60/360 (0.27/1.60)

CONCRETE

FASTENERS	CONCRETE STRENGTH PSI (Mpa)	ALLOWABLE/ULTIMATE TENSION LOADS Lbs (kN)

HOLLOW CONCRETE BLOCK

FASTENERS	ALLOWABLE/ULTIMATE TENSION LOADS Lbs (kN)
T4IFC-100 - T4IFC-600	35/184 (0.15/0.82)

TOOL ACCESSORIES



Part No. 019336
Battery-T4IF
Qty: 1



Part No. 018866
Battery Charger - T4IF
Qty: 1



Part No. T4FUEL
Fuel Cell - T4
Qty: 12 (4-3 packs)

Part No. 018578
Nose Piece - T4IF
Qty: 1

SELECTION CHART

FASTENERS FOR STEEL STUDS

PART NUMBER	DESCRIPTION	INSULATION THICKNESS	BOX QTY
T4IFS-100	1" Insulation Fastener w/fuel	1" (25 mm)	500
T4IFS-112	1-1/2" Insulation Fastener w/fuel	1-1/2" (38 mm)	500
T4IFS-200	2" Insulation Fastener w/fuel	2" (50 mm)	500
T4IFS-212	2-1/2" Insulation Fastener w/fuel	2-1/2" (63 mm)	500
T4IFS-300	3" Insulation Fastener w/fuel	3" (75 mm)	500
T4IFS-312	3-1/2" Insulation Fastener w/fuel	3-1/2" (89 mm)	500
T4IFS-400	4" Insulation Fastener w/fuel	4" (100 mm)	500
T4IFS-500	5" Insulation Fastener w/fuel	5" (125 mm)	500
T4IFS-600	6" Insulation Fastener w/fuel	6" (150 mm)	400
T4IF	T4 I-F Insulation Tool (6" Capacity)		1

FASTENERS FOR CONCRETE AND CMU

PART NUMBER	DESCRIPTION	INSULATION THICKNESS	BOX QTY
T4IFC-100	1" Insulation Fastener w/fuel	1" (25 mm)	500
T4IFC-112	1-1/2" Insulation Fastener w/fuel	1-1/2" (38 mm)	500
T4IFC-200	2" Insulation Fastener w/fuel	2" (50 mm)	500
T4IFC-212	2-1/2" Insulation Fastener w/fuel	2-1/2" (63 mm)	500
T4IFC-300	3" Insulation Fastener w/fuel	3" (75 mm)	500
T4IFC-312	3-1/2" Insulation Fastener w/fuel	3-1/2" (89 mm)	500
T4IFC-400	4" Insulation Fastener w/fuel	4" (100 mm)	500
T4IFC-412	4-1/2" Insulation Fastener w/fuel	4-1/2" (114 mm)	500
T4IFC-500	5" Insulation Fastener w/fuel	5" (125 mm)	500
T4IFC-600	6" Insulation Fastener w/fuel	6" (150 mm)	400
T4IF	T4 I-F Insulation Tool (6" Capacity)		1

PIN SPECIFICATIONS

- Made from AISI 1060-1065 steel. Austempered to a core hardness of 52-56 Rc
 Typical tensile strength: 270,000 psi
 Typical shear strength: 162,000 psi
 Standard finish
 - Proprietary black
 - Mechanical zinc plate to a minimum thickness of .0002 meets requirements of ASTM B695
 - Electroplated zinc with yellow chromate

APPROVALS/LISTING

ICC Evaluation Service, Inc.

#ESR-1955 T3 Fasteners

Fasteners in Concrete

FASTENER PART NUMBER	SHANK DIA. (INCH)	MINIMUM PENETRATION (INCH)	INSTALLED IN STONE AGGREGATE CONCRETE CONCRETE COMPRESSIVE STRENGTH ALLOWABLE LOAD – <i>Ultimate Load</i>						HOLLOW BLOCK Grade N, Type 1	
			4000 PSI		6000 PSI		3000 PSI Lightweight LOWER FLUTE		FACE SHELL Min 1-1/4" face thickness	
			TENSION (LBS)	SHEAR (LBS)	TENSION (LBS)	SHEAR (LBS)	TENSION (LBS)	SHEAR (LBS)	TENSION (LBS)	SHEAR (LBS)
MP034TH*	0.125	5/8	78 426	80 574	62 308	----	72 361	242 1210	133 691	----
		3/4	104 593	195 977	132 658	206 1057	93 470	288 1442	84 444	87 446
34CLIP	0.104/ .125	5/8	62 310	----	106 528	----	44 220	----	----	----
38HSMP034, 12HSMP034 34HSMP034, TSHMP034	0.104/ .125	5/8	60 357	117 587	107 533	191 957	54 269	230 1150	71 357	123 613

* ESR-1955 pin data applies. **Note 1:** ALLOWABLE loads are shown in the **LARGE BOLD** font, *Ultimate* loads are shown in *smaller italic* font. **Note 2:** Testing conducted in accordance with ICC AC70 & ASTM E1190
Note 3: Safety factors are based on coefficient of variation. In accordance with ICC AC70, the safety factor will be no less than 5. **Note 4:** Values shown in concrete are for fastener only. Connected members must be investigated separately. **Note 5:** Cyclic, fatigue, shock loads and other design criteria may require a different safety factor. **Note 6:** Job-site testing may be required to determine actual job site values. **Note 7:** Minimum edge distance is 3 inches unless otherwise approved. In hollow block applications, no more than one fastener per cell. **Note 8:** For SI: 1 lbf = 4.448 N, 1 inch = 25.4 mm, 1 ksi = 6.89MPa.

Intro to Powder Fastening Systems

Over a half century of leadership in powder actuated tools and fasteners

The first powder actuated tools (PATs) were used for repairing damaged ship hulls during World War I. This application continued through World War II, when the son of the original inventor, Stanley Temple, developed and implemented the technology for commercial use. In 1947, the "Tempotool" was introduced to the construction industry.

Ramset Fasteners was founded in 1948 to handle distribution and sales for the construction trades. In 1949, Ramset's accredited Operator Program was officially launched. Today this highly successful training program has instructed over 1,000,000 trades people in the safe use of PATs.

Today, Ramset continues to bring the industry the products, service and innovation that they have come to expect from the leader in powder fastening. All geared to help contractors do their job faster, more safely and more productively.



Training and Certification

DESCRIPTION

Ramset has designed and engineered the right powder actuated tool for your applications. To ensure you use a powder actuated tool correctly, please take the time to review the Operator's Safety and Operating Instruction Manual packaged with each tool. These manuals are also available for download on the Ramset website.

To assure safety on the jobsite, OSHA and ANSI require that all powder actuated tool users become trained and certified for the particular tool being used. One way Ramset enables you to receive this training is through our website training program. This innovative approach to education combines interactive web-based training techniques and online testing with immediate feedback to provide you a rich learning environment.

The course consists of approximately 30 pages of usage, safety and troubleshooting material.

Upon completion of this brief course you will have the opportunity to take an online exam. Instructions for taking these exams are provided at the end of the course. With successful completion of the exam, you have the opportunity to print a certification card.

As an industry leader in powder actuated fastening systems, Ramset continues to provide the most effective and comprehensive instructor and operator training programs available.

Test Fastening

Always make a test fastening using the lowest power level recommended for the particular tool. The chart on this page represents the Powder Load Identification by both color and number. Later in this course you will be asked to perform an exercise demonstrating that you can identify these loads.

It is also important that the test fastening is made after being sure that the base material is suitable for powder-actuated fastening. To do this, perform a Center Punch Test.

POWER LEVEL	LOAD COLOR	LOWER POWER
1	GRAY	↓ ↑ HIGHER POWER
2	BROWN	
3	GREEN	
4	YELLOW	
5	RED	
6	PURPLE	

Learning Aids

Ramset POWER FASTENING SYSTEMS

Safety Goggles and Hearing Protection

Safety practices are very important when using the Ramset Powder Actuated tools. Always wear safety goggles and hearing protection.

- Failure to wear safety goggles may result in serious eye injury from flying debris.
- Constant or repeated unprotected exposure to fastening noise may cause permanent hearing loss.

Ramset POWER FASTENING SYSTEMS

Proper Storage

To prevent use of a powder actuated tool by unlicensed individual, always store the tool unloaded and keep the tool and the loads securely locked in a tool box.

Ramset POWER FASTENING SYSTEMS

Visit ramset.ca for online PAT licensing

RA27 Fully Automatic P.A.T.

.27 Caliber Strip Tool
Fully-Automatic
1-1/2" Pin Capacity
(2" w/washer)



ACCESSORIES



Magazine Part Number: RA27MAG
Weight: 1.3 lbs
Maximum pin length: 1-1/4" Collated True Embedment only (TE_X) pins

DESCRIPTION/SUGGESTED SPECIFICATIONS

Fully-Automatic Strip Tool—

MOST COMMON APPLICATION DRYWALL TRACK TO CONCRETE!

Ramset's fully automatic RA27 powder-actuated tool lowers downtime and fatigue on commercial job sites. The RA27 stands up to the toughest use for interior and exterior applications. The RA-27 magazine attachment (P/N RA27MAG - sold separately) shoots Ramset's collated true embedment pins.

ADVANTAGES

- Lower pushdown force reduces fatigue
- Long-lasting piston reduces downtime
- Collar requires only ¼ turn for quicker cleaning
- More power load-for-load provides flexibility in a wide range of applications
- Power adjust dial provides the ability to dial down power for ideal pin embedment
- Patented RBC (Residue Build-up Channel) allows user to work longer between cleanings
- Back end padding absorbs recoil, reducing fatigue
- Belt/tether clip for safety
- Swivel lift/scaffold hook keeps the tool within reach at all times

MOST COMMON FASTENERS

PIN #	PIN LENGTH		MOST COMMON APPLICATION
	IN.	MM	
1512SD	1-1/2	38.1	Fasten with increased bearing surface against material to be fastened
SP12	1/2	12.7	Drywall track to structural steel
1506	3/4	19.1	Drywall track to concrete

See pages R 35 - R 36 for all fasteners.

COLLATED TRUE EMBEDMENT PINS

10-Pin Collated Stips for the Ramset RA27 with RA27MAG and other brands

PART #	PIN LENGTH		EMBEDMENT LENGTH	
	IN.	MM	IN.	MM
TE12X	9/16	13.84	1/2	12.7
TE34X	13/16	20.6	3/4	19.1
TE100X	1-1/16	27.05	1	25.4
TE114X	1-5/16	33.3	1-1/4	31.8

Shank diameter = .157 Head diameter = .320

SPECIFICATIONS

Tool Part No. RA27

.27 caliber 10-shot strip loads 3, 4, 5

Weight: 5.3 pounds

Length: 15"

Muzzle Bushing O.D.: 9/16"

Maximum Pin Length: 1-1/2" (2" w/washer)

3 year warranty

POWER LEVEL GUIDE FOR LOADS

All loads are color coded and load level numbered. As the number increases, the power level increases.

Always start with the lightest load. If the fastener does not set completely, use the next higher load and repeat the process.



Cobra+

.27 Caliber Strip Tool
Semi-Automatic
2-1/2" Pin Capacity
(3" w/washer)

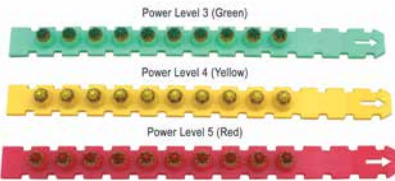

DESCRIPTION/SUGGESTED SPECIFICATIONS

Semi-Automatic Strip Tool—

MOST COMMON APPLICATION DRYWALL TRACK TO CONCRETE!

The Cobra+ can be used in different applications, a few are electrical junction boxes to steel or concrete, door and window frames to concrete, HVAC duct straps and forming work.

ADVANTAGES

- Semi-automatic .27-caliber tool —uses strip loads
- Padded recoil-absorbing handle—for greater operator comfort
- Power adjustable for maximum efficiency
- Silencer that reduces noises by 30%
- Ergonomic handle maximizes user comfort
- Fastens up to 3" standard Ramset drive pins and threaded studs—ideal for general construction applications
- Full one-year warranty

MOST COMMON FASTENERS

PIN #	PIN LENGTH		MOST COMMON APPLICATION
	IN.	MM	
1524SDP (washed)	3	76.2	2" x 4" to concrete
1516SDC (washed)	2-1/2	63.5	2" x 4" to concrete
1506	3/4	19.1	Drywall track to concrete

See pages R 35 - R 36 for all fasteners.

SPECIFICATIONS

Part No. COBRA+

.27 caliber 10-shot strip loads 2, 3, 4, 5

Weight: 5.25 pounds

Length: 15"

Muzzle Bushing O.D.: 9/16"

Maximum Pin Length: 3"

POWER LEVEL GUIDE FOR LOADS

All loads are color coded and load level numbered. As the number increases, the power level increases.

Always start with the lightest load. If the fastener does not set completely, use the next higher load and repeat the process.



Cobra+ InsulFast with Cobra+ conversion kit

Ramset's Semi-Automatic Powder Actuated Option for Insulation Fastening
Easy and Convenient Kit to Maximize Productivity



COBRAIFKIT Conversion Kit

DESCRIPTION/SUGGESTED SPECIFICATIONS

Semi-Automatic Strip Tool for Fastening Insulation to Concrete

MAXIMIZE YOUR PRODUCTIVITY AND COVER 2 APPLICATIONS WITH THE SAME TOOL!

The Cobra+ InsulFast Conversion Kit allows for an easy and convenient way to tackle 2 applications with the same great Cobra+ tool. Used it for your typical PAT application as well as for fastening rigid and semi-rigid insulation to concrete.

ADVANTAGES

- Fasten insulation to concrete up to 4X faster than traditional methods
- Convert your tool back and forth in less than 5 minutes
- Reduce heat loss/thermal bridging of common metal fasteners with InsulFast fasteners. See page R 20 for more info



SELECTION CHART

PART NUMBER	DESCRIPTION	INSULATION THICKNESS	QUANTITY PER BOX
COBRA+	Semi Automatic Strip Tool, 27 CAL	-	1
COBRAIFKIT	Cobra+ IF Conversion Kit	-	1
IG625PAT*	1" InsulFast Fasteners with Green Powder Loads Incl.	1" (25 mm)	100
IG638PAT*	1-1/2" InsulFast Fasteners with Green Powder Loads Incl.	1-1/2" (38 mm)	100
IG650PAT*	2" InsulFast Fasteners with Green Powder Loads Incl.	2" (50 mm)	100

* Other fastener lengths available on special request

* For more information on InsulFast fasteners see page R 18 and R 29, for more information on Cobra+ tool see page R 28

SPECIFICATIONS

Part No. COBRA+

.27 caliber 10-shot strip loads 2, 3, 4, 5

Weight: 5.25 pounds

Length: 15"

Part No. COBRAIFKIT

Includes: Piston assembly (P/N 585810), Pin guide (P/N 585821), Buffer (P/N 585822), and detailed installation instructions.

.22 Cal Single Shot Tools

Hammer Shot 22 Cal



Master Shot 22 Cal



TriggerShot 22 Cal



DESCRIPTION/SUGGESTED SPECIFICATIONS

Single Shot - Hammer Activation Tool—

The Ramset Hammer Shot .22 Caliber Single Shot Tool is a hammer-actuated tool utilizing .22 caliber loads. This tool is great for small DIY projects. The Hammer Shot can easily fasten up to 2-1/2 in. drive pins.

ADVANTAGES

- For small DIY projects, such as fastening two by fours and furring strips to concrete in basements or room additions
- Hammer-actuated tool with a barrel design that allows for easy horizontal and overhead fastening, up to 2-1/2 in. drive pins

SPECIFICATIONS

Part No. 45000
.22 caliber single shot loads 2,3,4
Actuated Tool Type: Load/Booster

DESCRIPTION/SUGGESTED SPECIFICATIONS

Single Shot Tool - Sound Suppression Technology

CAN FASTEN UP TO 3 INCH DRIVE PINS WITH WASHER

Designed for frequent use providing fastening results in a variety of concrete, masonry or steel applications.

- Noise-reducing design up to 30% quieter
- Powder load automatically ejects after each use.

ADVANTAGES

- For light and medium duty applications in concrete and steel
- Ideal for attaching 2 x 4s, furring strips and electrical boxes
- 90 Day Warranty
- Heavy-duty all-steel construction

SPECIFICATIONS

Part No. 45100
.22 caliber single shot loads 2,3,4
Weight: 4.1 pounds
Maximum Pin Length: 2-1/2" (3" w/washer)

DESCRIPTION/SUGGESTED SPECIFICATIONS

Single Shot - Trigger Activation —

For small DIY projects, such as fastening two by fours and furring strips to concrete in basements or room additions.

ADVANTAGES

- Trigger Actuated, No Hammer Required!
- For fastening to concrete, masonry or steel

SPECIFICATIONS

Part No. 45200
.22 caliber single shot loads 2,3,4
Weight: 3.7 pounds
Maximum Pin Length: 2-1/2" (3" w/washer)

FASTENERS – HOW THEY WORK

DESCRIPTION

FASTENING TO CONCRETE

As the fastener enters the concrete, extreme pressures and heat are created. This creates a bond that provides high loading strength in concrete.

FASTENING TO STEEL

The resilience of steel provides a clamping effect to the fastener. This combined with the tremendous heat that is created, provides a welding and clamping effect to give maximum holding power.

FASTENING PLACEMENT AND PENETRATION

The following represents the minimum edge and spacing requirements, plus base material thickness requirements:

CONCRETE

- Edge distance.** Do not fasten closer than 3 inches from the edge of concrete. If the concrete cracks, the fastener may not hold and may allow the fastener to ricochet, causing serious injury or death to the operator or bystanders.
- Recommended minimum fastener spacing.** Setting fasteners too close together can cause the concrete to crack. The recommended MINIMUM DISTANCE between fastening is three (3) inches. Never attempt a fastener application too close to another previously inserted fastener to prevent the second fastener from ricocheting off the previously installed fastener. A ricochet can result in serious injury or death to the operator or bystanders.

- Concrete thickness.** It is important that the concrete be at least three (3) times as thick as the fastener penetration. If the concrete is too thin, the compressive forces forming at the fastener's point can cause the free face of the concrete to break away. This creates a dangerous condition from flying concrete and/or the fastener and also results in a reduction of fastener holding power.

STEEL

- Edge distance.** The recommended edge distance for a fastener to the edge of steel is 1/2 inch. Never fire the tool within 1/2 inch of the edge of a steel base material because the steel may bend or break off, allowing the fastener to ricochet, causing serious injury or death to the operator or bystanders.
- Recommended minimum fastener spacing.** The recommended minimum distance between fastening is 1 inch. Never attempt a fastening application too close to another previously inserted fastener to prevent the second fastener from ricocheting off the previously installed fastener. A ricochet can result in serious injury or death to the operator or bystanders.
- Steel thickness.** Do not fasten into steel base material thinner than the fastener shank diameter. Holding power will be reduced and the fastener may be over-driven, creating a dangerous situation to the operator or bystanders due to a free-flying fastener.

HOW TO SELECT A POWDER ACTUATED FASTENER

Drive pins are used to directly fasten an object (permanent installation). **Threaded studs** are used where the object fastened is to be removed or where shimming is required. The following shows how to determine shank and thread length. Required penetration is determined by load requirement (illustrated in the following examples).

Ramset fasteners may be specified by their type or catalog number to satisfy fastening requirements.

Permanent Installation

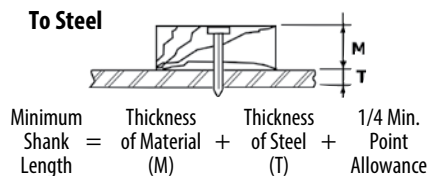
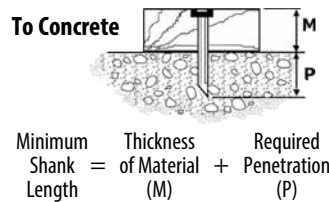

Removable Installation

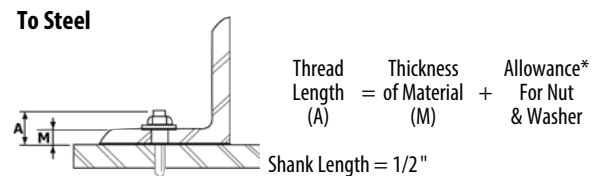
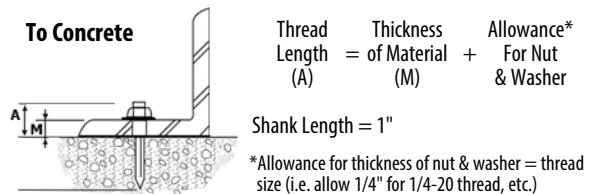

Fasteners – How They Work

SELECTING THE CORRECT FASTENER LENGTH

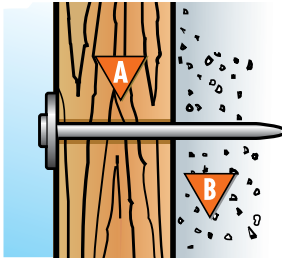

High quality fasteners provide consistent and reliable performance in concrete, block, masonry, and steel applications. Choosing the correct fastener for the job will assure professional results.

- A Determine thickness of material being attached.
- B Fastener must be long enough to drive approximately 1" into concrete, cement block or penetrate thickness of steel.

POWER LEVEL GUIDE FOR LOADS

All loads are color coded and load level numbered. As the number increases, the power level increases.

Always start with the lightest load. If the fastener does not set completely, use the next higher load and repeat the process.

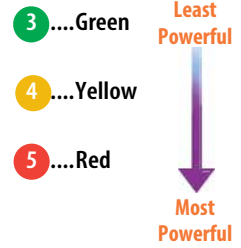

TYPICAL USES

WOOD ATTACHMENT*

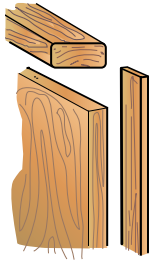

CONCRETE BASE MATERIAL

STRUCTURAL STEEL BASE

	COMMONLY USED FASTENER		COMMONLY USED LOAD		COMMONLY USED FASTENER		COMMONLY USED LOAD	
2 X 4	1516	(2-1/2")	YELLOW #4		SP178	(1-7/8")	RED #5	
3/4" Plywood for furring strip	1512	(1-1/2")	GREEN #3		1510	(1-1/4")	YELLOW #4	
1/4" – 1/2" Plywood	1512	(1-1/2")	GREEN #3		1506	(3/4")	YELLOW #4	

* USE RAMGUARD PIN FOR TREATED LUMBER. SEE PAGE 34.

THIN GAGE STEEL

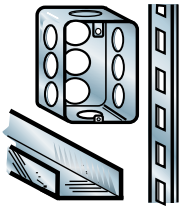

Electrical Junction Boxes	1508	(1")	GREEN #3		SP58TH	(5/8")	YELLOW #4	
Shelf Brackets	1508	(1")	GREEN #3		1506	(3/4")	YELLOW #4	
Interior Drywall Track	1506	(3/4")	BROWN #2		1503K	(1/2")	YELLOW #4	
Perimeter Track	1510	(1-1/4")	YELLOW #4		1503K	(1/2")	YELLOW #4	

NOTE This chart is presented as a guide only. Start with the lightest load. If the fastener does not set completely, use the next higher load and repeat the process. Product suggestions may not be suitable for all types of base materials. Contact Technical Services if you have further questions.

Troubleshooting

CONCRETE

SYMPTOM

FASTENER DOES NOT HOLD IN BASE MATERIAL OR BASE MATERIAL SPALLS

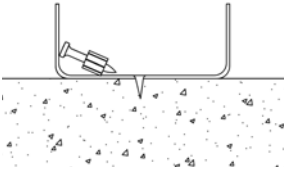

CAUSE

- | High strength concrete
- | Hard or large aggregate in concrete

ACTION

- | Use shorter fastener
- | Use PowerPoint pin
- | Use load with a different power level

FASTENER PENETRATES TOO DEEP

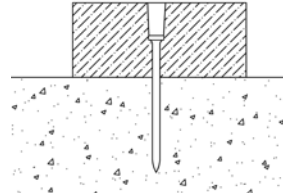

CAUSE

- | Fastener too short for application
- | Tool power level too high

ACTION

- | Use longer fastener
- | Use a lighter powder load

FASTENER DOES NOT PENETRATE DEEP ENOUGH

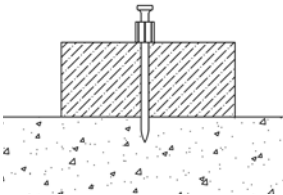

CAUSE

- | Fastener too long
- | Tool power level too low

ACTION

- | Use a shorter fastener
- | Use a stronger powder load

FASTENER BENDS

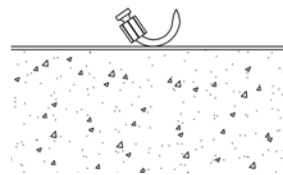

CAUSE

- | Fastener hit large aggregate on entry
- | Concrete too hard
- | Fastener hit rebar just under the surface

ACTION

- | Use shorter fastener
- | Use PowerPoint pin
- | Make sure tool is perpendicular to the work surface
- | Move over 3 inches, try to fasten again

STEEL

SYMPTOM

FASTENER DOES NOT PENETRATE THE SURFACE

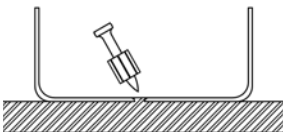

CAUSE

- | Driving power too low
- | Material may be too hard for forced entry fastener

ACTION

- | Increase powder load level
- | Use PowerPoint pin

FASTENER DOES NOT HOLD IN BASE MATERIAL

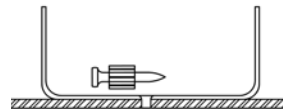

CAUSE

- | Steel base material is too thin

ACTION

- | Use gas system tools with smaller Shank pin or Tek pin

FASTENER BREAKS OR BENDS

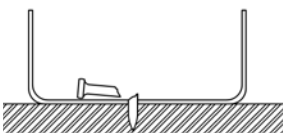

CAUSE

- | Driving power is too low
- | Fastener is too long
- | Material may be too hard for forced entry fastener

ACTION

- | Increase powder load level
- | Reduce fastener length

FASTENER DOES NOT FULLY PENETRATE STEEL

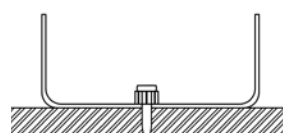

CAUSE

- | Driving power too low
- | Steel base material too thick
- | Application limit may have been reached

ACTION

- | Increase powder load level
- | Use PowerPoint pin

Problem Solving Pins

PowerPoint Pins for Hard Concrete & Steel Fastening



DESCRIPTION/SUGGESTED SPECIFICATIONS

Use Ramset's exclusive PowerPoint pins for your advanced fastening applications. They provide easier penetration into hard steel and concrete. That means reduced pin failures and increased holding values to make your jobs more productive.

ADVANTAGES

Consistent Performance, in Hard Steel and Hard Concrete

Standard powder actuated pins fasten inconsistently in steel. Frequently the steel is just too hard for conventional pins. Steel is also inconsistent because hardness varies. According to the steel industry's accepted Rockwell Hardness Scale (Rb), steel strength can vary from a relatively soft 54 Rb to an extremely hard 88 Rb or higher. Standard pins typically begin to fail in the upper 70s Rb. Tests, however, have proven that PowerPoint consistently performs, even as steel approaches 90 Rb!

AVERAGE IN PLACE FASTENER COSTS

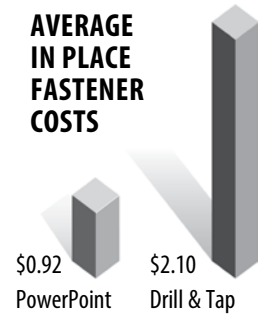

Notice in the photographs below how typical manufacturing processes can cause inconsistency in a pin's finish, increasing its likelihood of failure. And see the difference with Ramset's process! Which pin would you want to use?



Ramset's unique manufacturing process results in uniform shape and finish for more consistent performance.



Typical cut-point finish resulting from manufacturing process will increase pin failure



Typical swage-ballistic point finish results in potential failure of pin

SELECTION CHART

MATERIAL	BASE STEEL THICKNESS				
	3/16"	1/4"	3/8"	1/2"	3/4"
2' x 4' Plate	SP178	SP178	SP178	SP178	SP178
13 Ga. to 17 Ga.	SP12				
18 Ga. to 25 Ga.	SP12				



See page R 39 for fastener selection.

Ramguard™ Drive Pins for ACQ Pressure Treated Lumber!

As many of you know, there have been changes to the regulations affecting pressure treated lumber. The industry standard CCA treated wood is no longer being produced for residential use. Most new pressure treated wood is utilizing Alkaline Copper Quaternary (ACQ) treatment. It has been confirmed that ACQ corrodes steel 2 to 4 times faster than the old CCA treated lumber. This means that our standard drive pins are not recommended for use in ACQ treated lumber.

Ramset has developed a coating called Ramguard™ for use in all pressure treated wood including the new ACQ treated wood. The Ramguard coating offers excellent corrosion resistance that rivals hot dipped galvanized and stainless steel. Washered versions of these pins utilize a Ramguard coated pin and a washer with a G185 coating. This combination was developed to withstand the increased corrosion rate that sometimes occurs when using fasteners in the new treated lumber.

POWDER FASTENERS

DESCRIPTION

We maintain only the highest standards in the materials, production techniques and quality control measures used to manufacture our fasteners, assuring consistent, optimum quality in every fastener.

ADVANTAGES

BLACK PINS

The special black coating improves pin penetration into difficult base material (i.e. hard concrete). We offer this black coating on all of our fasteners manufactured for the attachment of drywall track and channel to concrete and steel.

PINS

ITW Ramset powder actuated fasteners are specifically fabricated to meet the exacting requirements of toughness and durability that enable them to penetrate dense concrete and structural quality steel.

FASTENER TERMINOLOGY SUFFIX

- K = Knurled
- B = Black
- E = Ramguard
- X = Collated
- SD = Washer
- C = 100 count
- M = 1000 count

Plated Drive Pins

Designed for use in concrete and structural steel applications.
 100 per box.



PART NUMBER	SHANK LENGTH IN. (MM)	BOX QTY	MASTER CASE QTY	ROCKET	XT540	SA270/TS750P	RAZ7	COBRA	D45/D45A	D60	721	RS22/HD22	DX 351	DX 36	DX 350	DX 460	DX A40	DX A41	DX 35	DX E72	
1503K	1/2 Knurled (12.7)	100	5,000																		
1506	3/4 (19.1)	100	1,200																		
1508	1 (25.4)	100	1,200																		
1510	1-1/4 (31.8)	100	1,000																		
1512	1-1/2 (38.1)	100	1,200																		
1514	2 (50.8)	100	800																		
1516	2-1/2 (63.5)	100	800																		
1524	3 (76.2)	100	600																		

Shank diameter = .145 Head diameter = .300

Plated Drive Pins (25 Packs)

Designed for use in concrete and structural steel applications.



PART NUMBER	SHANK LENGTH IN. (MM)	BOX QTY	MASTER CASE QTY	ROCKET	XT540	SA270/TS750P	RAZ7	COBRA	D45/D45A	D60	721	RS22/HD22	DX 351	DX 36	DX 350	DX 460	DX A40	DX A41	DX 35	DX E72	
R50122	1-1/2 (38.1)	25	125																		
R50124	2 (50.8)	25	125																		
R50126	2-1/2 (63.5)	25	125																		
R50128	Multi Pack	200	1,000																		

Shank diameter = .145 Head diameter = .300

Plated Drive Pins with 7/8" Washer

Washer increases bearing surface against the material to be fastened. 100 per box. 16 gage metal washer.



PART NUMBER	SHANK LENGTH IN. (MM)	BOX QTY	MASTER CASE QTY	ROCKET	XT540	SA270/TS750P	RAZ7	COBRA	D45/D45A	D60	721	RS22/HD22	DX 351	DX 36	DX 350	DX 460	DX A40	DX A41	DX 35	DX E72	
1508SD	1 (25.4)	100	1,000																		
1510SD	1-1/4 (31.8)	100	1,000																		
1512SD	1-1/2 (38.1)	100	1,000																		
1516SDC	2-1/2 (63.5)	100	600																		
1524SDP*	3 (76.2)	100	600																		

Shank diameter = .145 Head diameter = .300 * Square washer indicates 3" pin has been installed.

Powder Fasteners

PowerPoint Step Shank Pins

Used for fastening into hard concrete and steel. Premium hard concrete and steel pin. 100 per box.



PART NUMBER	SHANK LENGTH IN. (MM)	BOX QTY	MASTER CASE QTY	ROCKET	XT540	SA270/ T5750P	RA27	COBRA	D45/ D45A	D60	721	RS22/ HD22	DX 351	DX 36	DX 350	DX 460	DX A40	DX A41	DX 35	DX E72	
SP12*	1/2 (12.7)	100	1,200	■	■	■		■	■	■	■	■	■	■	■	■	■	■	■	■	■
SP34*	3/4 (19.1)	100	1,000	■	■	■	■	■	■	■	■	■	■	■	■	■	■	■	■	■	■
SP114	1-1/4 (31.8)	100	5,000				■														
SP178	1-7/8 (47.6)	100	1,000	■		■	■	■	■	■	■	■	■	■	■	■	■	■	■	■	■

Shank diameter = .150/.180

Head diameter = .300

* Shank diameter = .150, Regular PowerPoint pin without Step Shank.

Top Hat Drive Pins

Increases bearing surface against material to be fastened for improved attachment to inconsistent base materials. 100 per box.



PART NUMBER	SHANK LENGTH IN. (MM)	BOX QTY	MASTER CASE QTY	ROCKET	XT540	SA270/ T5750P	RA27	COBRA	D45/ D45A	D60	721	RS22/ HD22	DX 351	DX 36	DX 350	DX 460	DX A40	DX A41	DX 35	DX E72	
SP58TH	5/8 (15.9)	50	5,000	■	■	■	■	■	■	■	■	■	■	■	■	■	■	■	■	■	■

Shank diameter SP58TH and SP34TH = .150 1906 and 1908 = .145 Head diameter = .300

Ramguard Pins

Coated to improve corrosion resistance in treated lumber and other applications. 100 per box.



PART NUMBER	SHANK LENGTH IN. (MM)	BOX QTY	MASTER CASE QTY	ROCKET	XT540	SA270/ T5750P	COBRA	D45/ D45A	D60	721	RS22/ HD22	DX 351	DX 36	DX 350	DX 460	DX A40	DX A41	DX 35	DX E72	
1516E	2-1/2 (63.5)	100	800		■	■	■				■		■	■	■		■			■
1524SDE*	3 (76.2)	100	600		■	■	■				■				■		■			■

Shank diameter = .145 * .150/.180

Head diameter = .300

Fastener Ceiling Clips

14 gage angle clip. 100 clips per box.



PART NUMBER	DESCRIPTION
1202CF	Angle clip (no pin)

Hole diameter: 5/16" & 14/64"

True Embedment Pins

10-Pin Collated Strips for the Ramset RA27 with RA27MAG and other brands

PART NUMBER	BOX QTY	MASTER CASE QTY	RA27 (with magazine)	XT540 (with magazine)
TE12X	1,000	5,000	■	■
TE34X	1,000	5,000	■	■
TE100X	1,000	5,000	■	■
TE114X	1,000	5,000	■	■

Hole diameter: 5/16" & 14/64" Shank diameter = .157 Head diameter = .320

Powder Loads

High Quality and Dependability



CW Series

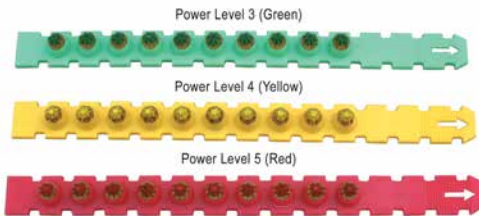

RS27 Series

DESCRIPTION/SUGGESTED SPECIFICATIONS

ITW Ramset powder loads and tools match tolerances to provide optimum power within recognized national velocity standards. Available in color-coded 10-load discs, 10-load strips and 100-load boxes.

Caution: Always test-fasten with the lowest power level for your tool. If more power is necessary, use the next highest power level until proper level and fastening is achieved. Refer to the operator's manual for more specific details. Observe all safety reminders. Tool operators must be trained and qualified as required by federal law. Failure to use properly can result in serious injury or death to users or bystanders.

Advantages Powder Guide

Power level is designated by the load level number marked on each box and by the color of the box and each powder load. As the number increases, the power level increases.

POWER LEVEL GUIDE FOR LOADS

All loads are color coded and load level numbered. As the number increases, the power level increases.



Always start with the lightest load. If the fastener does not set completely, use the next higher load and repeat the process.

SELECTION CHART

0.22 CALIBER, SINGLE SHOT LOAD

PART NUMBER	POWER LEVEL-COLOR	721	M70	HD22 RS22	DXE37	DXE72	BOX QTY WT (LBS)	CASE QTY WT (LBS)
C22CW	2 - Brown	■	■	■	■	■	100/0.2	1,200/2.4
C32CW	3 - Green	■	■	■	■	■	100/0.2	1,200/2.4
C42CW	4 - Yellow	■	■	■	■	■	100/0.2	1,200/2.4

0.22 CALIBER, SINGLE SHOT LOAD (25 PACKS)

PART NUMBER	POWER LEVEL-COLOR	721	M70	HD22 RS22	DXE37	DXE72	BOX QTY WT	CASE QTY WT
R50116	3 - Green	■	■	■	■	■	25	125
R50118	4 - Yellow	■	■	■	■	■	25	125

10-SHOT, 0.27 CALIBER, STRIP LOAD

PART NUMBER	POWER LEVEL-COLOR	ROCKET	RA27	COBRA+	COBRA III	SAZ70	TS750P	XT540	DX36M	DX350	DX351	DX450	DX460	DXA40	DXA41	BOX QTY WT (LBS)	CASE QTY WT (LBS)
C3RS27	3 - Green	■	■	■	■	■	■	■	■	■	■	■	■	■	■	100/0.3	600/1.8
C4RS27	4 - Yellow	■	■	■	■	■	■	■	■	■	■	■	■	■	■	100/0.3	600/1.8
C5RS27	5 - Red	■	■	■	■	■	■	■	■	■	■	■	■	■	■	100/0.3	600/1.8

SUGGESTED SPECIFICATIONS

Ramset provides the architect and engineer, the following suggested language and helpful information for the purpose of fastening specifications.

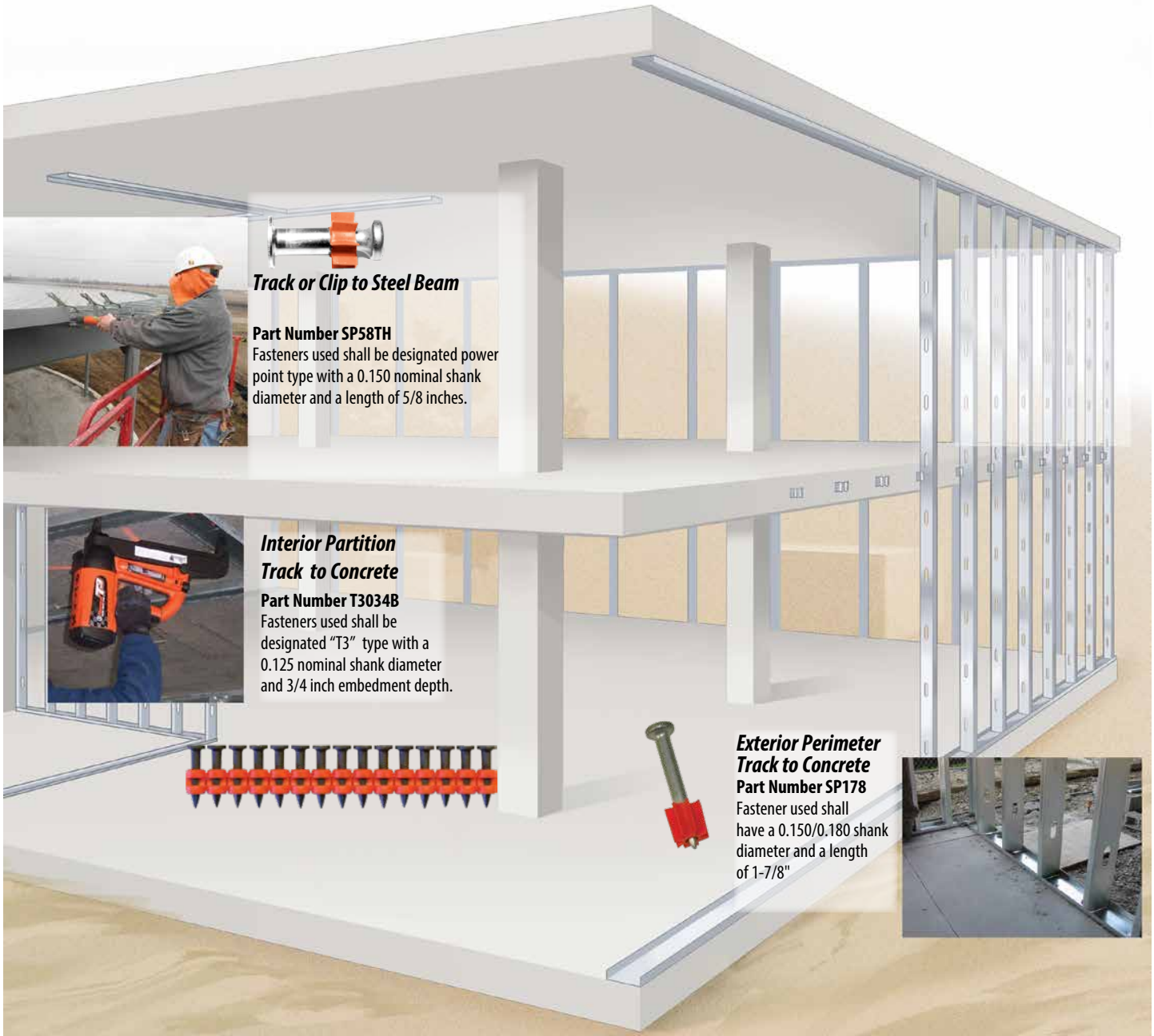

Track or Clip to Steel Beam

Part Number SP58TH

Fasteners used shall be designated power point type with a 0.150 nominal shank diameter and a length of 5/8 inches.

Interior Partition Track to Concrete

Part Number T3034B

Fasteners used shall be designated "T3" type with a 0.125 nominal shank diameter and 3/4 inch embedment depth.

Exterior Perimeter Track to Concrete

Part Number SP178

Fastener used shall have a 0.150/0.180 shank diameter and a length of 1-7/8"

For assistance with specifications and/or substitutions, contact Technical Service at 800-387-9692.

POWDER PERFORMANCE/SUBMITTAL

Ramset fasteners may be specified by their type or catalog number to satisfy fastening requirements.

PIN SPECIFICATIONS

Made from AISI 1060-1065 steel. Austempered to a core hardness of 52-56 Rc
 Typical tensile strength: 270,000 psi
 Typical shear strength: 162,000 psi
 Standard finish
 - Proprietary black
 - Mechanical zinc plate to a minimum thickness of .0002 meets requirements of ASTM B695

APPROVALS/LISTING

ICC Evaluation Service, Inc.

#ER-1147 Sill Plate

#ESR-1799 Powder Pins & Clips

City of Los Angeles

#RR-22668 Powder pins

PERFORMANCE TABLES

Fasteners in Normal Weight Concrete

PART NUMBER SERIES	SHANK DIAMETER (INCH)	MINIMUM PENETRATION (INCH)	INSTALLED IN STONE AGGREGATE CONCRETE CONCRETE COMPRESSIVE STRENGTH ALLOWABLE LOAD – <i>Ultimate Load</i>							
			2000 PSI				4000 PSI		6000 PSI	
			TENSION (LBS)		SHEAR (LBS)		TENSION (LBS)	SHEAR (LBS)	TENSION (LBS)	SHEAR (LBS)
1500/ 1600 SERIES	0.145	3/4	50 <i>655</i>	66 <i>739</i>	100 <i>511</i>	104 <i>552</i>	-----	-----	-----	-----
		1	152 <i>943</i>	166 <i>1229</i>	157 <i>937</i>	182 <i>1342</i>	-----	-----	-----	-----
		1-1/4	159 <i>1078</i>	265 <i>1665</i>	179 <i>1043</i>	267 <i>1538</i>	-----	-----	-----	-----
		1-1/2	154 <i>1450</i>	340 <i>2027</i>	209 <i>1357</i>	342 <i>1712</i>	-----	-----	-----	-----
SP	0.150	3/4	-----	-----	150 <i>803</i>	105 <i>786</i>	81 <i>493</i>	82 <i>454</i>	-----	-----
SP SERIES	.150/.180	1	154 <i>1043</i>	200 <i>1173</i>	243 <i>1307</i>	175 <i>1037</i>	189 <i>1125</i>	210 <i>1177</i>	-----	-----
		1-1/4	207 <i>1553</i>	230 <i>1636</i>	298 <i>1749</i>	218 <i>1471</i>	213 <i>1568</i>	305 <i>1780</i>	-----	-----
		1-1/2	-----	-----	384 <i>2126</i>	391 <i>1957</i>	239 <i>1886</i>	594 <i>2968</i>	-----	-----
3300 SERIES	0.180	1	196 <i>1084</i>	100 <i>1328</i>	255 <i>1504</i>	284 <i>1557</i>	-----	-----	-----	-----
		1-1/4	241 <i>1207</i>	329 <i>1710</i>	294 <i>1574</i>	373 <i>2104</i>	-----	-----	-----	-----
		1-1/2	254 <i>1601</i>	379 <i>1971</i>	419 <i>2239</i>	501 <i>2505</i>	-----	-----	-----	-----
1900	0.145	3/4	105 <i>694</i>	71 <i>458</i>	101 <i>685</i>	99 <i>627</i>	-----	-----	-----	-----
9100 STUD	0.205	1	187 <i>988</i>	212 <i>1385</i>	186 <i>1070</i>	303 <i>1618</i>	-----	-----	-----	-----
		1-1/4	262 <i>1450</i>	304 <i>1674</i>	335 <i>2161</i>	400 <i>2000</i>	-----	-----	-----	-----

Note 1: ALLOWABLE loads are shown in the **LARGE BOLD** font, *Ultimate* loads are shown in *smaller italic* font. **Note 2:** Testing conducted in accordance with ICC AC70 & ASTM E1190. **Note 3:** Safety factors are based on coefficient of variation. In accordance with ICC AC70, the safety factor will be no less than 5. **Note 4:** Values shown in concrete are for the fastener only. Connected members must be investigated separately. **Note 5:** Cyclic, fatigue, shock loads, and other design criteria may require a different safety factor. **Note 6:** Job site testing may be required to determine actual job site values. **Note 7:** Minimum edge distance is 3 inches unless otherwise approved. **Note 8:** For SI: 1 lbf = 4.448 N, 1 inch = 25.4 mm, 1 ksi = 6.89MPa

PERFORMANCE TABLES

Fasteners in Steel

PART NUMBER SERIES	SHANK DIA. (INCH)	TYPE OF SHANK	INSTALLED IN A36 STRUCTURAL STEEL—STEEL THICKNESS (INCHES)									
			ALLOWABLE LOAD — <i>Ultimate Load</i>									
			3/16		1/4		3/8		1/2		3/4	
TENSION (LBS)	SHEAR (LBS)	TENSION (LBS)	SHEAR (LBS)	TENSION (LBS)	SHEAR (LBS)	TENSION (LBS)	SHEAR (LBS)	TENSION (LBS)	SHEAR (LBS)	TENSION (LBS)	SHEAR (LBS)	
1500/1600	0.145	SMOOTH	81 <i>790</i>	373 <i>2039</i>	181 <i>1269</i>	273 <i>1642</i>	397 <i>2169</i>	489 <i>2771</i>	243 <i>1328⁸</i>	277 <i>1514⁸</i>	----	----
		KNURLED	296 <i>1633</i>	636 <i>3516</i>	584 <i>3384</i>	659 <i>3822</i>	680 <i>3755</i>	730 <i>4030</i>	253 <i>1459⁸</i>	293 <i>1632⁸</i>	----	----
SP	0.150	SMOOTH	385 <i>2107</i>	662 <i>3618</i>	445 <i>2549</i>	477 <i>2736</i>	393 <i>2145</i>	574 <i>3137</i>	948 <i>5180</i>	597 <i>3500</i>	234 <i>1244⁸</i>	356 <i>1895⁸</i>
3300	0.180	SMOOTH	281 <i>1536</i>	580 <i>3169</i>	385 <i>2212</i>	507 <i>2931</i>	460 <i>2631</i>	644 <i>3518</i>	641 <i>3499</i>	684 <i>3739</i>	----	----
9100	0.205	KNURLED	160 <i>1469</i>	931 <i>5084</i>	350 <i>3115</i>	617 <i>3542</i>	843 <i>4605</i>	803 <i>4391</i>	565 <i>3086⁹</i>	547 <i>3373⁹</i>	----	----

PART NUMBER SERIES	SHANK DIA. (INCH)	TYPE OF SHANK	INSTALLED IN A572 GRADE 50 STRUCTURAL STEEL—STEEL THICKNESS (INCHES)									
			ALLOWABLE LOAD — <i>Ultimate Load</i>									
			3/16		1/4		3/8		1/2		3/4	
TENSION (LBS)	SHEAR (LBS)	TENSION (LBS)	SHEAR (LBS)	TENSION (LBS)	SHEAR (LBS)	TENSION (LBS)	SHEAR (LBS)	TENSION (LBS)	SHEAR (LBS)	TENSION (LBS)	SHEAR (LBS)	
1500/1600	0.145	SMOOTH	----	----	----	----	----	----	----	----	----	----
		KNURLED	260 <i>1609</i>	499 <i>3182</i>	579 <i>3411</i>	725 <i>4272</i>	383 <i>2216⁷</i>	595 <i>3431⁷</i>	----	----	----	----
SP	0.150	SMOOTH	356 <i>2123</i>	569 <i>3394</i>	554 <i>3232</i>	637 <i>3710</i>	604 <i>3447</i>	602 <i>3437</i>	814 <i>4473⁹</i>	820 <i>4503⁹</i>	243 <i>1362⁸</i>	381 <i>2141⁸</i>
3300	0.180	SMOOTH	----	----	----	----	----	----	----	----	----	----
9100	0.205	KNURLED	365 <i>2175</i>	903 <i>5385</i>	697 <i>4061</i>	907 <i>5285</i>	155 <i>842⁷</i>	376 <i>2143⁷</i>	----	----	----	----

Note 1: ALLOWABLE loads are shown in the **LARGE BOLD** font, *Ultimate* loads are shown in *smaller italic* font. **Note 2:** Testing conducted in accordance with ICC AC70 & ASTM E1190. **Note 3:** Safety factors are based on coefficient of variation. In accordance with ICC AC70, the safety factor will be no less than 5. **Note 4:** Cyclic, fatigue, shock loads, and other design criteria may require a different safety factor. **Note 5:** Job site testing may be required to determine actual job site values. **Note 6:** Values shown are for fastenings that have the entire pointed end of the fastener driven through the steel plate; except as noted below. **Note 7:** Fastener penetration is 3/8" minimum. **Note 8:** Fastener penetration is 7/16" minimum. **Note 9:** Fastener penetration is 1/2" minimum. **Note 10:** For Sl: 1 lbf = 4.448 N, 1 inch = 25.4 mm, 1 ksi = 6.89MPa

Fasteners in Lightweight Concrete

PART NUMBER SERIES	SHANK DIAMETER (INCH)	MINIMUM PENETRATION (INCH)	ALLOWABLE WORKING VALUES INSTALLED IN 3000 PSI LIGHTWEIGHT CONCRETE							
			ALLOWABLE LOAD — <i>Ultimate Load</i>							
			3000 PSI LIGHTWEIGHT W/DECKING				3000 PSI LIGHTWEIGHT			
LOWER FLUTE TENSION		LOWER FLUTE SHEAR		TENSION		SHEAR				
1500 SERIES	0.145	3/4	76 <i>395</i>	260 <i>1409</i>	167 <i>837</i>	179 <i>894</i>				
		1	134 <i>668</i>	265 <i>1505</i>	200 <i>998</i>	228 <i>1141</i>				
		1-1/4	157 <i>784</i>	269 <i>1344</i>	333 <i>1664</i>	400 <i>2090</i>				
		1-1/2	233 <i>1163</i>	346 <i>1728</i>	391 <i>1957</i>	410 <i>2050</i>				
SP SERIES	.150/.180	1	119 <i>593</i>	336 <i>1679</i>	226 <i>1129</i>	250 <i>1249</i>				
		1-1/4	175 <i>957</i>	372 <i>1860</i>	329 <i>1644</i>	377 <i>1885</i>				
		1-1/2	179 <i>1055</i>	426 <i>2128</i>	406 <i>2030</i>	380 <i>1900</i>				
9100 SERIES	0.205	3/4	70 <i>351</i>	277 <i>1386</i>	----	----				
		1	112 <i>559</i>	378 <i>1891</i>	----	----				
		1-1/4	118 <i>689</i>	----	----	----				

Note 1: ALLOWABLE loads are shown in the **LARGE BOLD** font, *Ultimate* loads are shown in *smaller italic* font. **Note 2:** Testing conducted in accordance with ICC AC70 & ASTM E1190. **Note 3:** Safety factors are based on coefficient of variation. In accordance with ICC AC70, the safety factor will be no less than 5. **Note 4:** Values shown in concrete are for the fastener only. Connected members must be investigated separately. **Note 5:** Cyclic, fatigue, shock loads, and other design criteria may require a different safety factor. **Note 6:** Job site testing may be required to determine actual job site values. **Note 7:** For Sl: 1 lbf = 4.448 N, 1 inch = 25.4 mm, 1 ksi = 6.89MPa

TE POWDER PERFORMANCE/SUBMITTAL

Ramset fasteners may be specified by their type or catalog number to satisfy fastening requirements.

PIN SPECIFICATIONS

Made from AISI 1060-1065 steel. Austempered to a core hardness of 52-56 Rc
 Typical tensile strength: 270,000 psi
 Typical shear strength: 162,000 psi

Standard Finishes

Mechanical zinc plate to a minimum thickness of .0002 meets requirements of ASTM B695—Class 5 Type 1

APPROVALS/LISTING

ICC Evaluation Service, Inc.

#ESR-2690 Sill Plate

#ESR-1799 Powder Pins & Clips

City of Los Angeles

#RR-22668 Powder pins

PERFORMANCE TABLES

Fasteners in Normal Weight Concrete

PART NUMBER SERIES	SHANK DIAMETER (INCH)	MINIMUM PENETRATION (INCH)	INSTALLED IN SOLID CONCRETE CONCRETE COMPRESSIVE STRENGTH ALLOWABLE LOAD – <i>Ultimate Load</i>											
			2000 PSI				4000 PSI				6000 PSI			
			TENSION (LBS)		SHEAR (LBS)		TENSION (LBS)		SHEAR (LBS)		TENSION (LBS)	SHEAR (LBS)		
TE	0.157	3/4	71	<i>627</i>	116	<i>713</i>	71	<i>559</i>	116	<i>685</i>	109	<i>753</i>	117	<i>712</i>
		1	197	<i>986</i>	216	<i>1463</i>	258	<i>1390</i>	216	<i>1421</i>	214	<i>1313</i>	383	<i>1998</i>
		1-1/4	264	<i>1399</i>	283	<i>1626</i>	377	<i>1886</i>	317	<i>1846</i>	415	<i>2074</i>	349	<i>1858</i>
		1-1/2	212	<i>1453</i>	297	<i>1719</i>	242	<i>1211</i>	479	<i>2393</i>	-----	-----	-----	-----

Fasteners in Lightweight Concrete

PART NUMBER SERIES	SHANK DIAMETER (INCH)	EMBED (INCH)	3000 PSI LIGHTWEIGHT CONCRETE			
			TENSION (LBS)		SHEAR (LBS)	
TE SERIES	0.157	3/4	152	<i>1010</i>	159	<i>998</i>
		1	325	<i>1625</i>	347	<i>1737</i>
		1-1/4	358	<i>1790</i>	437	<i>2239</i>
		1-1/2	466	<i>2332</i>	478	<i>2392</i>

Note 1: ALLOWABLE loads are shown in the **LARGE BOLD** font, Ultimate loads are shown in smaller italic font. **Note 2:** Testing conducted in accordance with ICC AC70 & ASTM E1190. **Note 3:** Safety factors are based on coefficient of variation. In accordance with ICC AC70, the safety factor will be no less than 5. **Note 4:** Values shown in concrete are for the fastener only. Connected members must be investigated separately. **Note 5:** Cyclic, fatigue, shock loads, and other design criteria may require a different safety factor. **Note 6:** Job site testing may be required to determine actual job site values. **Note 7:** Minimum edge distance is 3 inches unless otherwise approved. **Note 8:** For SI: 1 lbf = 4.448 N, 1 inch = 25.4 mm, 1 ksi = 6.89MPa

PERFORMANCE TABLES

Installed in A36 Structural Steel (inches)

PART NUMBER SERIES	SHANK DIA. (INCH)	SHANK TYPE	3/16		1/4		3/8		1/2		≥ 3/4	
			TENSION	SHEAR	TENSION	SHEAR	TENSION	SHEAR	TENSION	SHEAR	TENSION	SHEAR
TE SERIES	0.157	KNURLED	323 <i>1739</i>	606 <i>3257</i>	562 <i>3022</i>	673 <i>3621</i>	934 <i>5095</i>	820 <i>4473</i>	603 <i>3286</i>	766 <i>4178</i>	343 ⁶	496 ⁶

Installed in A572-GR50 Structural Steel (inches)

PART NUMBER SERIES	SHANK DIA. (INCH)	SHANK TYPE	3/16		1/4		3/8		1/2		≥ 3/4	
			TENSION	SHEAR	TENSION	SHEAR	TENSION	SHEAR	TENSION	SHEAR	TENSION	SHEAR
TE SERIES	0.157	KNURLED	442 <i>2400</i>	676 <i>3674</i>	630 <i>3747</i>	662 <i>3942</i>	760 <i>4421</i>	725 <i>4218</i>	582 ⁵ <i>3188</i>	532 ⁵ <i>2851</i>	311 ⁵	469 ⁵

- Notes:**
- 1) Fasteners tested to ASTM E1190 & ICC-ES AC70
 - 2) Allowable loads are shown in bold font, ultimate loads are shown in smaller, italic font
 - 3) Allowable loads and safety factors are based on coefficient of variation in accordance with ICC AC70, the safety factor will be no less than 5
 - 4) Values shown for steel base materials have the pointed end of the fastener driven through the steel plate
 - 5) Fastener penetration into steel must be minimum 7/16 inch
 - 6) Fastener penetration into steel must be minimum 3/8 inch
 - 7) For SI: 1 lbf = 4.448 N, 1 inch = 25.4 mm, 1 ksi = 6.89MPa

Fasteners Installed Through Metal Deck into Minimum 3,000 PSI Lightweight Concrete

PART NUMBER SERIES	SHANK DIAMETER (INCH)	SHANK DESCRIPTION	MINIMUM PENETRATION (INCH)	3-INCH DEEP W TYPE STEEL DECK		1-1/2 INCH DEEP B TYPE STEEL DECK			
						UPPER FLUTE		LOWER FLUTE	
				TENSION (LBS)	SHEAR (LBS)	TENSION (LBS)	SHEAR (LBS)	TENSION (LBS)	SHEAR (LBS)
TE	0.157	SMOOTH-TAPERED	3/4	106 <i>529</i>	265 <i>1326</i>	131 <i>656</i>	261 <i>1305</i>	154 <i>769</i>	307 <i>1537</i>
			1	152 <i>761</i>	327 <i>1634</i>	156 <i>782</i>	273 <i>1365</i>	138 <i>692</i>	265 <i>1326</i>
			1-1/4	164 <i>821</i>	330 <i>1650</i>	-----	-----	-----	-----
			1-1/2	238 <i>1191</i>	448 <i>2240</i>	-----	-----	-----	-----

- Note 1:** ALLOWABLE loads are shown in the LARGE BOLD font, Ultimate loads are shown in smaller italic font. **Note 2:** Testing conducted in accordance with ICC AC70 & ASTM E1190. **Note 3:** Safety factors are based on coefficient of variation. In accordance with ICC AC70, the safety factor will be no less than 5. **Note 4:** Values shown in concrete are for the fastener only. Connected members must be investigated separately. **Note 5:** Cyclic, fatigue, shock loads, and other design criteria may require a different safety factor. **Note 6:** Job site testing may be required to determine actual job site values. **Note 7:** Minimum edge distance is 3 inches unless otherwise approved. **Note 8:** For SI: 1 lbf = 4.448 N, 1 inch = 25.4 mm, 1 ksi = 6.89MPa

Fasteners Driven into Concrete Masonry Units (CMU Block)

PART NUMBER SERIES	SHANK DIAMETER (INCH)	EMBED	HOLLOW UNGROUTED CMU				GROUT-FILLED CMU					
			FACE SHELL		MORTAR JOINT		FACE SHELL		MORTAR JOINT		TOP OF GROUTED CELL	
			TENSION	SHEAR	TENSION	SHEAR	TENSION	SHEAR	TENSION	SHEAR	TENSION	SHEAR
TE	0.157	1	33 <i>329</i>	100 <i>693</i>	42 <i>443</i>	68 <i>746</i>	139 <i>875</i>	145 <i>936</i>	91 <i>950</i>	127 <i>1328</i>	165 <i>851</i>	171 <i>922</i>

- For SI: 1 Inch = 25.4 mm, 1 lbf = 4.448 N.
 Fasteners must be installed a minimum of 5.1 inches from the end of the wall.
 Fasteners must be installed at the center of the CMU cell. No more than one fastener may be installed in an individual CMU cell
 Applicable to fasteners installed in the horizontal mortar joint (bed joint). Minimum fastener spacing must be 5.1 inches
 Allowable shear load value applies to load applied perpendicular to the mortar joint
 Fastener must be installed vertically at the top, center of grouted cell
 Shear load can be in any direction perpendicular to the axis of the fastener

TE Embedment depth is easily identifiable by head stamps.



Notes

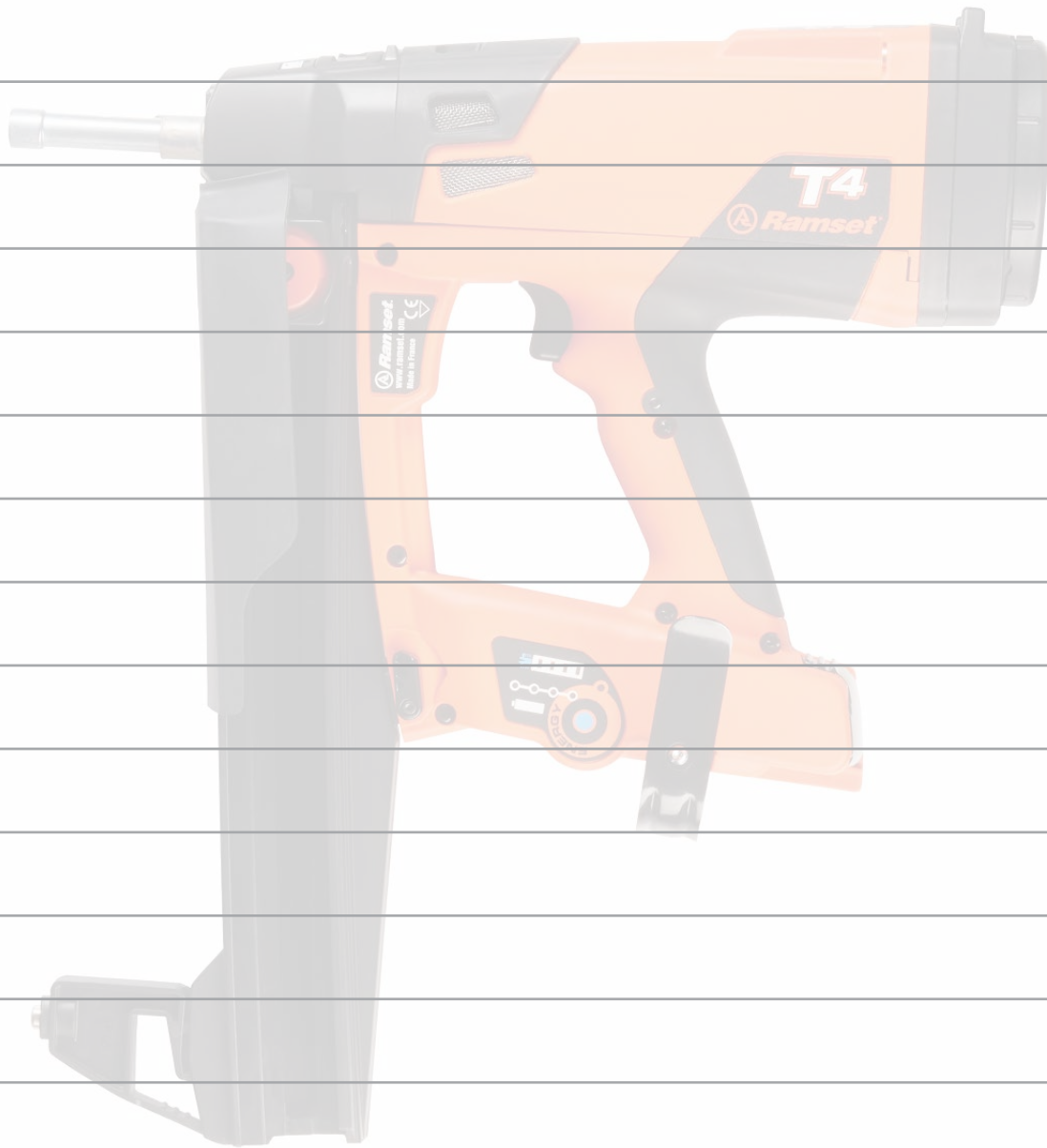

National Headquarters

120 Travail Road
Markham, Ontario, L3S 3J1

Tel: 905-471-7403
800-387-9692

Fax: 905-471-7208
800-668-8688

Technical and Customer Service Support

Tel: 800-387-9692

Fax: 800-668-8688

Regional Warehouses

- Markham, Ontario
- Calgary, Alberta

Take Advantage of these Contractor Services from ITW Construction Products Canada

From job sites to engineering firms, from Safety Seminars to on-site services, we hope you take advantage of our many contractor services— at no charge! After all, it's one thing to offer the quality products you need to do your job. It's another to provide you with superior service, engineering expertise and total product support.

At ITW Construction Products Canada, we are proud of the partnerships we have built through the years with our distributor network and contractors. Thanks to quality products, innovative services and on-time delivery, we will continue to build new relationships and strengthen existing ones today... and into the next century.

- Factory representatives with years of training and service experience will go out to your job site to provide you with product, service and technical assistance.
- We provide architects and engineers with complete submittal packages which gives them the technical data needed to specify ITW Construction Products Canada products. Contact your ITW Construction Products Canada Distributor or your nearest Customer Service location to request submittal packages.

Technical Application Assistance:

- Our staff of application specialists are ready to assist you with any type of application or code approval question during any phase of your project. Call 1-800-387-9692 between 8:00 a.m. and 5:00 p.m. EST, Monday through Friday.

Distributed By



The information and recommendations in this document are based on the best information available to us at the time of preparation. We make no other warranty, expressed or implied, as to its correctness or completeness, or as to the results or reliance of this document.

Ramset, T4, T3, T3Cup, Trakfast, GypFast, Mastershot, Triggershot, Hammershot, PowerPoint, TE Pin and Climacoat are trademarks of Illinois Tools Works, Inc.

A7+, C6+, Dynabolt, G5, Hammer-Set, LDT, Multi-Set II, Poly Set, Red Head, Redi-Drive, S7, Striker, and Trubolt are trademarks of ITW Red Head and Illinois Tool Works, Inc.

Teks, TruGrip GT, Scots, Maxiseal, Dek-Cap, Tapcon, SG, Tapcon, Maxi-Set Tapcon, Condrive, E-Z Ancor, E-Z Toggle, Twist-N-Lock, E-Z Lite, E-Z Mini, Stud Solver, Hi-Lo, S-12, Backer-On, Rock-On, Decking, Dec-U-Drive, Dek-Cap, Grid-Mate, Grid-Mate, PB, Climaseal, Spex, Climacoat, UltraShield, Climashield and Building Ideas That Work are trademarks of ITW Buildex and Illinois Tool Works, Inc.

Sammys, Sammy X-Press, Sammy X-Press It, Sammy X-Press Swivel, Sammy X-Press Sidewinder, Tapcon, Sammy Saddle, Speedy Pole Tool, Spot-Rite Level, and Truss-T Hanger are trademarks of ITW Buildex and Illinois Tool Works, Inc.

The term "Paslode" is a trademark and the Paslode logo and all related product and service names, designs and slogans are Paslode trademarks. Paslode, RounDrive, Impulse, Positive Placement are registered trademarks, PowerFramer and quicklode are trademarks of Illinois Tool Works.

R4, RSS, Kameleon, Fin/Trim, RT Composite, Low Profile Cabinet, Pheinox, Top Star, VWS, Caliburn, and The GRK Fasteners Canada Ltd. and all associated designs and logos are trademarks of GRK Fasteners Canada Ltd., used under license.

Hiiti is a registered trademark of Hilti, Corp.

DensGlass is a registered trademark of Georgia Pacific Building Products.

Dekstrip, Dektite, Retrofit Dektite, and Dektite are registered trademarks of Deks Industries Pty Ltd.

Phillips Square-driv is a registered trademark of the Phillips Screw Company.